

Amerock®

2023-2024

Retail

The Finer Details!
HERSHBERGER'S
hardware ltd.

TABLE OF CONTENTS

| | |
|---------------------|-----|
| ▪ Amerock | 5 |
| ▪ Belwith Keeler | 83 |
| ▪ Elements | 131 |
| ▪ Fasteners | 170 |
| ▪ H Select | 53 |
| ▪ Jeffrey Alexander | 93 |
| ▪ Wood Handles | 75 |
| ▪ Wood Knobs | 73 |

INFORMATION

WAREHOUSE LOCATION

1411 Twp Rd 178
Baltic, OH 43804

WAREHOUSE HOURS

Monday - Friday 6:30 AM - 3:30 PM

DIRECT LINES FOR QUESTIONS OR ORDERS

330-897-7701

FAX ORDERS 330-897-3366

CUSTOMER SERVICE 330-897-0002

Monday - Friday 6:30 AM - 3:30 PM

EMAIL orders.hershbergerhardware@emyprinter.net

OHIO SALES

Josh Mast 330-763-3837

OUR GUARANTEE

30 Day 100% Satisfaction Money Back Guarantee

RETURNS

After 30 days subject to restocking fee

MINIMUM ORDER POLICY

\$5.00 minimum order charge on all orders
under \$25.00 no exceptions

SHIPPING CHARGES

Free local delivery

ACCOUNT POLICIES

1% ten day discount on all approved

Net 30 accounts

Call customer service to apply

PRICES SUBJECT TO CHANGE WITHOUT NOTICE

H-Select

New Display Boards

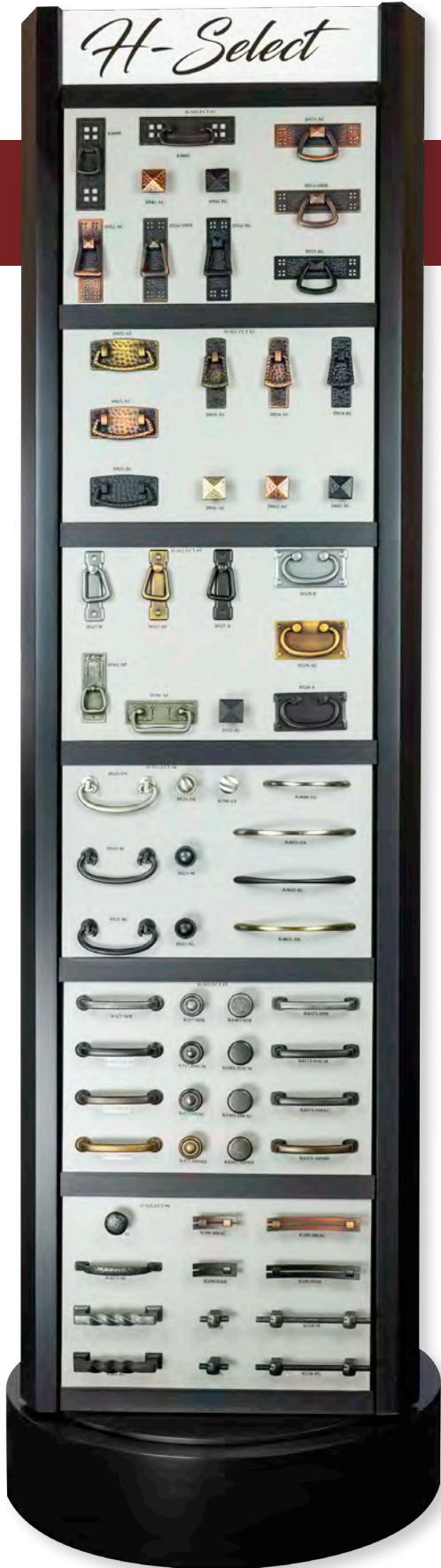

Unit Swivels to
Display Three Sides.

H-Select

BOARD 1



BOARD 5



BOARD 2



BOARD 6



BOARD 3



BOARD 7



BOARD 4



BOARD 8

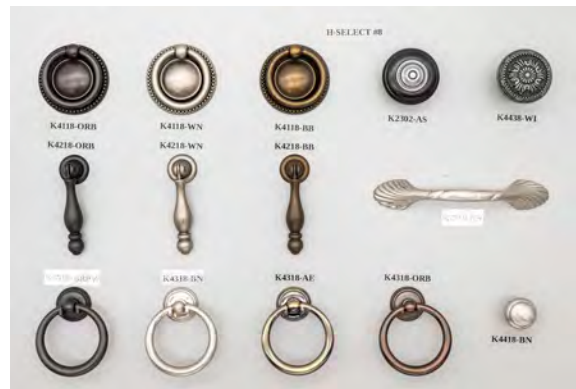

H-Select

BOARD 9



BOARD 13



BOARD 10



BOARD 14



BOARD 11



BOARD 15



BOARD 12



BOARD 16



H-Select

BOARD 17



BOARD 18

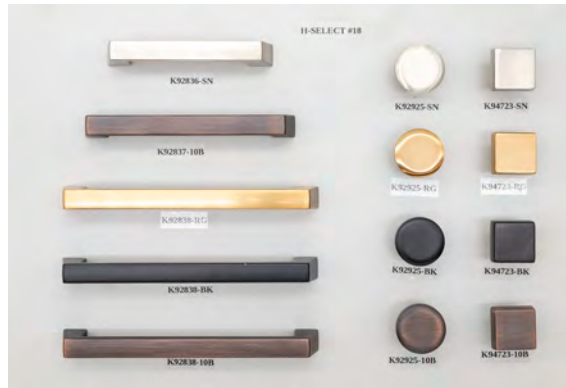

BOARD 19











Amerock®















FULL LINE MASTER DISTRIBUTOR OF AMEROCK
THIS PAGE FOR COLOR REFERENCE ONLY

SILVER TONES

| | | | | | |
|--|--|--|---|--|--|
|  |  |  |  |  |  |
| 26, CH POLISHED CHROME | PN POLISHED NICKEL | G10, SN SATIN NICKEL (MATTE) | SC SILVER CHAMPAGNE | G9 STERLING NICKEL | S SILVER |
|  |  |  |  |  |  |
| G10 SATIN NICKEL | 14 NICKEL | SS STAINLESS STEEL | AA ANODIZED ALUMINUM | 26D, SCH BRUSHED CHROME | BBN BLACK BRUSHED NICKEL |
|  |  |  |  |  |  |
| BCR BLACK CHROME | AS ANTIQUE SILVER | AP AGED PEWTER | AN ANTIQUE NICKEL | WN WEATHERED NICKEL | WNC WEATHERED NICKEL COPPER |

GOLD TONES

| | | | | | |
|---|---|---|--|---|---|
|  |  |  |  |  |  |
| CZ CHAMPAGNE BRONZE | BBZ BRUSHED BRONZE OR GOLDEN CHAMPAGNE | 3, PB POLISHED BRASS | GB GILDED BRONZE | AE ANTIQUE ENGLISH | EB ELEGANT BRASS |
|  |  |  |  |  |  |
| O77, BB BURNISHED BRASS | AB, ABS ANTIQUE BRASS | DBS DISTRESSED BRASS | R1 REGENCY BRASS | R2 WEATHERED BRASS | R3 RUSTIC BRASS |

THIS PAGE FOR COLOR REFERENCE ONLY

BOLD TONES



AC
ANTIQUE COPPER



BC
BRUSHED COPPER



WC
WEATHERED
COPPER



RBZ
RUSTIC BRONZE



CBZ
CARMEL BRONZE



ART
ANTIQUE RUST

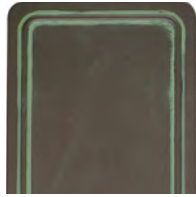

VS
VIRIDIAN SLATE



RB
ROMAN BRONZE



VB
VENETIAN
BRONZE



ORB
OIL-RUBBED
BRONZE



DOB
DARK OILED
BRONZE

BLACK TONES



WI, WID
WROUGHT IRON
OR WROUGHT
IRON DARK



PWT
PEWTER



GM
GUNMETAL



GPH
GRAPHITE



BN, BNB
BLACK NICKEL



BBR
BLACK BRONZE



FB
FLAT BLACK



CB
COLONIAL BLACK



MB
MATTE BLACK

MISCELLANEOUS TONES



30, W, 54, GW
WHITE



MW
MARBLE WHITE

EVERYDAY HERITAGE



1910-G10
 | 1/4" DIA
 | 1/8" PROJ



G10



1387-26
 | 1/4" DIA
 | 1/16" PROJ



G10 26



69151-G10
 | 1/2" DIA
 3/4" PROJ



G10



3413-26
 | 1/2" DIA
 5/8" PROJ



26



53000-G10
 | 1/4" DIA
 7/8" PROJ



G10



53002-G10
 | 3/16" DIA
 1" PROJ



ORB G10



53011-G10
 | 1/4" DIA
 | 1/8" PROJ



FB ORB G10 26



53015-G10
 | 1/4" DIA
 1" PROJ



FB ORB G10 26



53018-G10
 | 3/8" L
 | 1/2" PROJ



ORB G10 26



29112-CS
 | 3/16" DIA
 | 1/4" PROJ



CS



29113-G10
 | 1/4" DIA
 3/4" PROJ



ORB G10



29115-G10
 | 1/2" DIA
 | 1/8" PROJ



G10



4476-G10
 40MM L
 7/8" PROJ



FB G10



594-AE
 | 1/2" DIA
 7/8" PROJ



AE



3423-BB
 | 1/2" DIA
 1" PROJ



BB



888-AE
 | 3/8" DIA
 5/8" PROJ



AE



3401-CB
 3 1/4" C/C | 5 1/16" L



CB



3403-CB
 | 1/4" DIA
 3/4" PROJ



CB



53470-ORB
 3" C/C | 3 3/4" L



ORB G10



53471-ORB
 32MM DIA
 | 3 1/4" PROJ



ORB G10



53004-ORB
 96MM C/C | 4 3/4" L



ORB BB G10



53001-ORB
 | 1/4" DIA
 7/8" PROJ



FB ORB



3441-3
3" C/C | 3 3/8" L



29111-G10
128MM C/C | 6" L



3424-BB
3" C/CN | 5" L

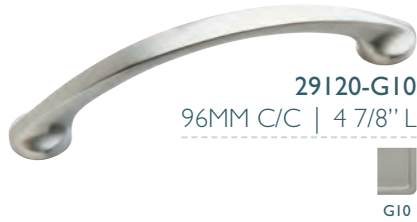

29120-G10
96MM C/C | 4 7/8" L



735-AE
3" C/C | 4 3/4" L



52994-G10
96MM C/C | 4 9/16" L



766-AE
2 1/2" C/C
4 13/16" L



52995-G10
96MM C/C | 5" L



173-ORB
3" C/C | 4 5/8" L



52996-G10
96MM C/C | 4 13/16" L



174-ORB
3" C/C | 5 1/16" L

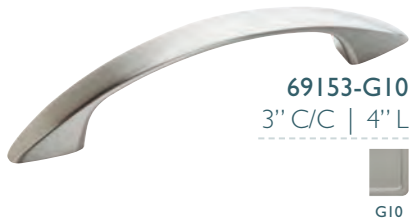

69153-G10
3" C/C | 4" L

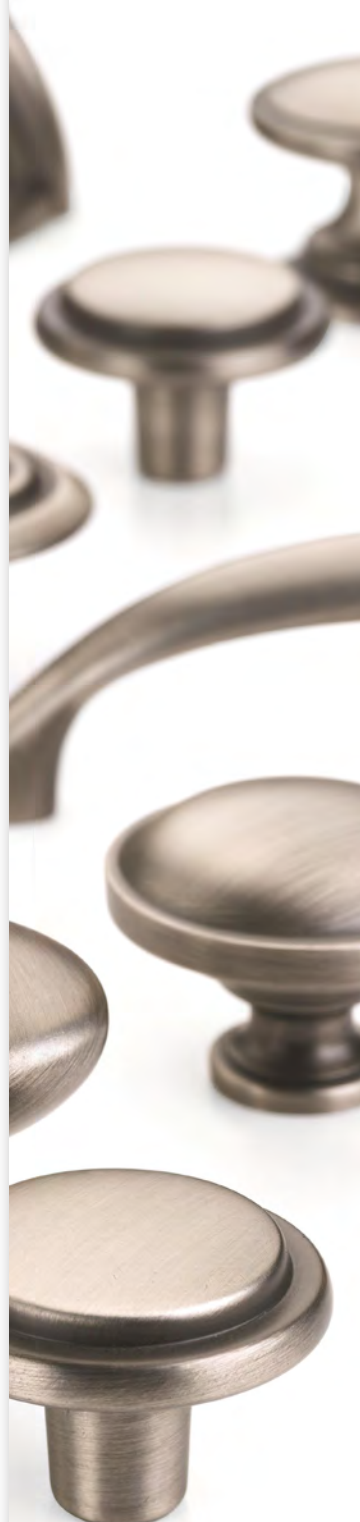

EVERYDAY HERITAGE



4478-G10
96MM C/C | 4" L

G10

4479-G10
96MM C/C | 4 7/16" L

ORB G10

3415-26
2 3/4" C/C | 3 1/2" L

26

3416-26
3" C/C | 4" L

26

865-26D
3" C/C | 3 5/16" L

26

867-CS26D
3 1/2" C/C | 3 13/16" L

CS26D CSG10

53006-G10
3" C/C | 3 3/8" L

FB ORB G10 26

53007-G10
3" C/C | 5 1/8" L

G10

53008-G10
3" C/C | 4 7/8" L

G10

53009-G10
3" C/C | 3 3/8" L

G10

1908-G10
3" C/C | 5 1/2" L

G10

76312-G10
4" C/C | 4 1/4" L

G10

76313-26
4" C/C | 4 1/4" L

26

ABERNATHY

AVAILABLE FINISHES

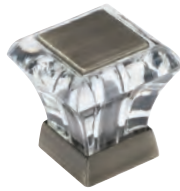

29460-CAS
1" L | 1" PROJ



AVAILABLE FINISHES



36743-BCR
4 13/16" C/C | 5 13/16" L



36744-BCR
4 9/16" C/C | 7 3/4" L



36745-BCR
6 9/16" C/C | 9 3/4" L



36746-BCR
8 9/16" C/C | 11 11/16" L



ALOFT

AVAILABLE FINISHES



36758-CZ
1 1/4" DIA
1" PROJ



36762-CZ
76MM C/C | 4 7/8" L



36764-CZ
76MM C/C | 3 3/4" L



36759-CZ
96MM C/C | 4 9/16" L



36763-CZ
128MM C/C | 7 7/16" L



36760-CZ
128MM C/C | 5 13/16" L



36761-CZ
192MM C/C | 8 5/16" L



APPOINT

ASHBY

AVAILABLE FINISHES



36640-GM
76MM C/C | 5 1/8" L

BAR PULLS



19010-SS
3" C/C | 5 3/8" L



CSG9 SS



19011-SS
96MM C/C | 6 1/8" L



CSG9 SS



19541-SS
128MM C/C | 7 3/8" L



CSG9 SS

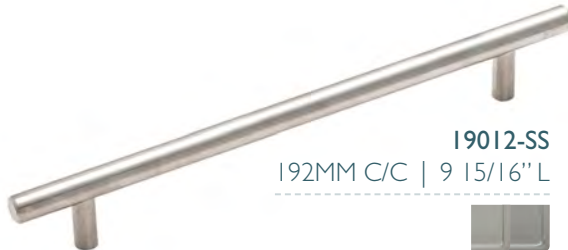

19012-SS
192MM C/C | 9 15/16" L



CSG9 SS



19013-SS
256MM C/C | 13 1/4" L



CSG9 SS

BAR PULLS

19009-ORB
2" L | 1 3/8" PROJ



40515-ORB
3" C/C | 5 3/8" L



40516-ORB
96MM C/C | 6 1/8" L



40517-ORB
128MM C/C | 7 3/8" L

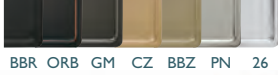

40518-ORB
192MM C/C | 9 7/8" L

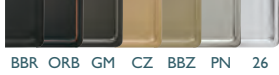

40519-ORB
256MM C/C | 13 1/4" L

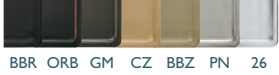

54008-ORB
12" C/C | 14 5/8" L



19014-ORB
320MM C/C | 15 3/4" L



19015-ORB
416MM C/C | 19 1/2" L



54025-ORB
18" C/C | 20 5/8" L



19016-ORB
480MM C/C | 22" L



19017-ORB
544MM C/C | 24 9/16" L



19018-ORB
640MM C/C | 28 3/8" L



19019-ORB
768MM C/C | 33 3/8" L



BLACKROCK

AVAILABLE FINISHES



55274-BBZ
1 13/16" L | 3/4" PROJ



55270-BBZ
1 5/16" DIA | 1" PROJ



55275-BBZ
3" C/C | 3 3/4" L



55272-BBZ
1 5/8" DIA | 1 1/4" PROJ



55276-BBZ
96MM C/C | 4 5/8" L



55277-BBZ
128MM C/C | 6" L



55271-BBZ
1 3/16" L | 1 1/16" PROJ



55278-BBZ
160MM C/C | 7 1/4" L



55273-BBZ
1 1/2" L | 3/8" PROJ



55279-BBZ
8" C/C | 9 3/8" L



55280-BBZ
12" C/C | 13 3/8" L



55281-BBZ
18" C/C | 19 3/8" L



BLYPHE



55220-VB
2 5/8" L | 1 1/3" PROJ



55222-WN
3" C/C | 3 3/5" L



AVAILABLE FINISHES



BRONX



36557-GM
3" OR 3 3/4" C/C | 4 11/16" L



36558-GM
5 1/16" C/C | 5 15/16" L



36559-GM
6 5/16" C/C | 7 3/16" L



36562-GM
8" C/C | 8 7/8" L



36560-GM
10 1/16" C/C | 11" L



36561-GM
12 5/8" C/C | 13 1/2" L



36556-GM
2 5/8" C/C | 5/8" L



CALATHEA

AVAILABLE FINISHES

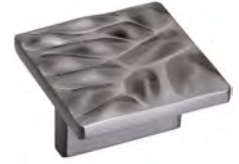

10132-BCR
1 1/4" L | 1 1/8" PROJ



100396-BCR
3 3/4" C/C | 4 7/16" L



1003128-BCR
5 1/16" C/C | 5 11/16" L



1003160-BCR
6 5/16" C/C | 7" L



CALIBER

AVAILABLE FINISHES



36872-ORB
1 1/4" DIA | 1 3/16" PROJ



36873-ORB
96MM C/C | 5 7/8" L



36874-ORB
128MM C/C | 7 1/8" L



36875-ORB
160MM C/C | 8 7/16" L



36876-ORB
192MM C/C | 9 11/16" L



36877-ORB
256MM C/C | 12 3/16" L



CANDLER

AVAILABLE FINISHES



29340-BBZ
1 1/4" L | 1 1/8" PROJ



29368-BBZ
1 1/2" L
1 1/4" PROJ



BBR ORB GM AS BBZ PN G10



29365-BBZ
8" C/C | 9 7/8" L





29349-BBZ
3" C/C | 4 3/8" L



29355-BBZ
96MM C/C | 5 1/8" L



29366-BBZ
12" C/C | 14 5/8" L

29363-BBZ
128MM C/C | 6 1/2" L



BBR ORB GM AS BBZ PN G10



29364-BBZ
160MM C/C | 8" L



BBR ORB GM AS BBZ PN G10



29367-BBZ
18" C/C | 20 3/4" L



BBR ORB AS BBZ PN G10



CARRIONE

AVAILABLE FINISHES



36648-MW/BBZ
3 3/4" C/C | 6 5/16" L



36647-MW/BBZ
2 1/2" L | 1 9/16" PROJ



36649-MW/BBZ
5 1/16" C/C | 7 1/2" L



36650-MW/BBZ
6 5/16" C/C | 8 3/4" L



CLASSICS

AVAILABLE FINISH



WI



771-WI
1 5/16" DIA | 1 1/4" PROJ

CONCENTRIC

AVAILABLE FINISHES



MB GM BBZ G10 PN



36830-GM
3 3/4" C/C | 4 1/2" L



36831-GM
5 1/16" C/C | 5 3/4" L

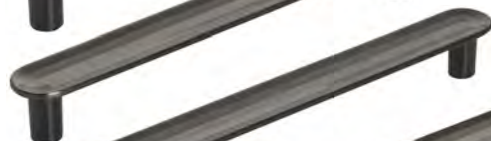

36832-GM
6 5/16" C/C | 7" L



36833-GM
7 9/16" C/C | 8 1/4" L



36834-GM
10 1/16" C/C | 10 3/4" L



36812-PN
3 3/4" CC | 4 3/16" L



36813-PN
5 1/16" CC | 5 7/16" L



36814-PN
6 5/16" CC | 6 11/16" L



36815-PN
7 9/16" CC | 7 15/16" L



36816-PN
10 1/16" CC | 10 7/16" L



36810-GM
1 9/16" DIA | 1 9/16" L



36811-PN
1 1/4" CC | 1 11/16" L

CONRAD

AVAILABLE FINISHES



29203-G10
39MM L | 1" PROJ

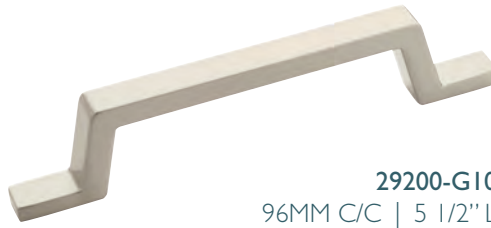

29200-G10
96MM C/C | 5 1/2" L



29202-G10
96MM C/C | 5 1/4" L

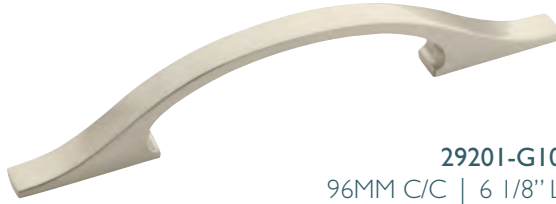

29201-G10
96MM C/C | 6 1/8" L



AVAILABLE FINISHES



36593-BBZ
3 3/4" C/C | 4 11/16" L



36594-BBZ
5 1/16" C/C | 6 1/16" L



36595-BBZ
6 5/16" C/C | 7 3/8" L



36613-BBZ
1 3/8" DIA | 1 3/16" PROJ

CRAWFORD



AVAILABLE FINISH



27017-AA
128MM C/C | 5 7/8" L

CREASED BOW



CUP PULLS



9365-ORB
64MM C/C | 4 1/8" L



ART ORB G10



53019-G10
2 1/2" C/C | 3 1/8" L



FB G10



53010-G10
3" C/C | 3 3/8" L



FB BN AS ORB BBZ G10 PN 26

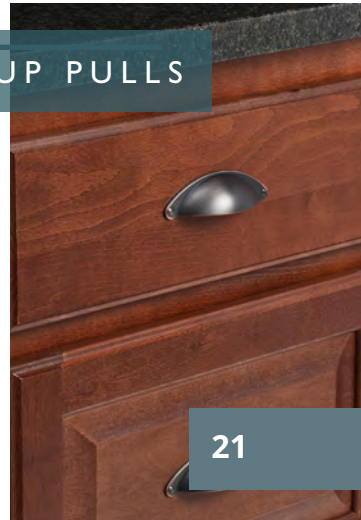

CYPRUS

AVAILABLE FINISHES



26201-BBZ
3" C/C | 5 1/4" L

26203-BBZ
96MM C/C | 6 9/16" L

9362-BBZ
128MM C/C | 7 3/16" L

26204-BBZ
160MM C/C | 9 1/8" L

26205-BBZ
8" C/C | 12" L

26206-BBZ
12" C/C | 16" L

26207-BBZ
18" C/C | 22" L

DAVENPORT

AVAILABLE FINISHES



36600-ORB
3" C/C | 4 1/2" L

36605-ORB
3 3/4" C/C | 5 5/16" L

36606-ORB 1 1/2" L | 1 3/8" PROJ
5 1/16" C/C | 6 9/16" L

36607-ORB
6 5/16" C/C | 7 13/16" L

36601-ORB
1 1/4" L | 1 3/16" PROJ

36602-ORB

DESTINE

AVAILABLE FINISHES



36857-G10
1 3/8" L | 1" PROJ

36858-G10
96MM C/C | 4 15/16" L

36859-G10
128MM C/C | 6 3/16" L

36860-G10
160MM C/C | 7 7/16" L

36861-G10
224MM C/C | 9 15/16" L



AVAILABLE FINISHES



DIVINITY



19258-G10
3" C/C | 1 1/4" L

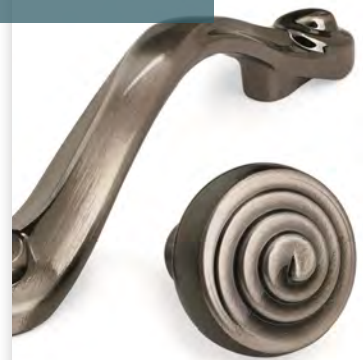

AVAILABLE FINISHES



EDGE PULLS

36573-ORB
3" C/C | 3 7/8" L

36574-ORB
96MM C/C | 4 9/16" L

36575-ORB
128MM C/C | 5 13/16" L



EDONA

AVAILABLE FINISHES



53005-CZ

1 1/4" DIA | 1 1/8" PROJ

ERA

AVAILABLE FINISHES



36907-G10

1 1/4" DIA | 1 1/8" PROJ

ESQUIRE

AVAILABLE FINISHES



36556-G10ORB
2 5/8" L | 1 1/2" PROJ



36557-G10ORB
3" C/C | 4 11/16" L



36558-G10ORB
128MM C/C | 5 15/16" L



36559-G10ORB
160MM C/C | 7 3/16" L



36560-G10ORB
256 MM C/C | 11" L



36561-G10ORB
320MM C/C | 13 1/2" L

AVAILABLE
FINISH



G10



24001-WNC
40MM DIA
1 1/8" PROJ



WNC

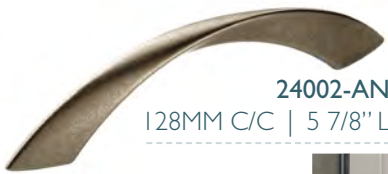

24002-AN
128MM C/C | 5 7/8" L



AN SN



19203-G10
128MM C/C | 6" L



19259-G10
3" C/C | 4 1/2" L



29409-G10
3" C/C | 4 3/8" L

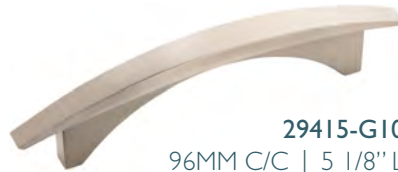

29415-G10
96MM C/C | 5 1/8" L



29416-G10
128MM C/C | 6 3/8" L

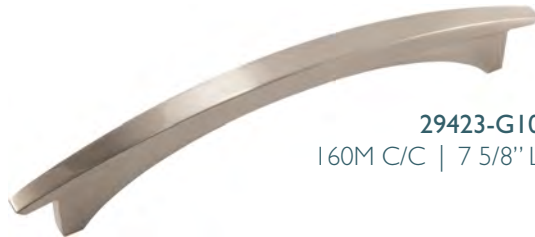

29423-G10
160M C/C | 7 5/8" L

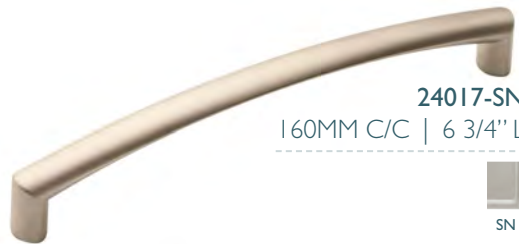

24017-SN
160MM C/C | 6 3/4" L



SN



24018-SN
96MM C/C | 4 1/8" L



SN



ESSENTIAL'Z STAINLESS STEEL



AVAILABLE FINISH



SS

24015-SS
128MM C/C | 5 5/8" L

24013-SS
128MM C/C | 5 9/16" L



19008-SS
1/4" DIA
1/8" PROJ

19001-SS
3" C/C | 3 5/8" L



SS SN

19002-SS
96MM C/C | 4 9/16" L

19003-SS
128MM C/C | 5 15/16" L

19004-SS
160MM C/C | 7 3/8" L

19005-SS
192MM C/C | 8 7/8" L



26200-SS
32MM DIA
1" PROJ

EXCEED



AVAILABLE FINISHES



FB CZ G10 26

36881-CZ
96MM C/C | 5 1/4" L

36882-CZ
128MM C/C | 6" L

36883-CZ
160MM C/C | 7 1/4" L

36884-CZ
224MM C/C | 9 13/16" L



36880-CZ
1 1/2" DIA | 1 3/16" PROJ

EXTENSITY

AVAILABLE FINISHES



29379-G10
3" C/C | 4 1/8" L



29385-G10
96MM C/C | 5" L



29393-G10
128MM C/C | 6 1/4" L



29394-G10
160MM C/C | 7 1/2" L



29370-G10
1 3/16" L | 1 1/16" PROJ



29398-G10
1 1/2" L | 1 1/8" PROJ



AVAILABLE FINISHES



36750-BCR
4 13/16" C/C | 5 13/16" L



36751-BCR
4 9/16" C/C | 7 3/4" L



36752-BCR
6 9/16" C/C | 9 3/4" L



36753-BCR
8 9/16" C/C | 11 11/16" L

EXTENT



FACTOR



AVAILABLE FINISHES

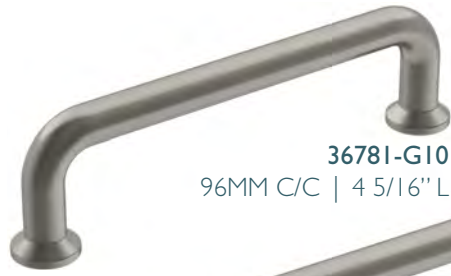

36781-G10
96MM C/C | 4 5/16" L



36782-G10
128MM C/C | 5 9/16" L



36782-G10
128MM C/C | 8 1/8" L



36780-G10
1 1/4" DIA | 1 1/16" PROJ

FORGINGS



4424-WI
3" C/C | 4 1/8" L



ORB WI G10



4426-WI
3" C/C | 4" L



WI



4428-WI
3" C/C | 4 1/8" L



RBZ WI



4425-WI
1 1/4" DIA
1 1/8" PROJ



ORB WI G10



4429-WI
1 1/8" L
1 1/8" PROJ



RBZ WI

GLACIO

AVAILABLE FINISHES



36659-CGM
3" C/C | 4 9/16" L



36654-CGM
3 3/4" C/C | 5 5/16" L



36655-CGM
5 1/16" C/C | 6 9/16" L



36656-CGM
6 5/16" C/C | 7 7/8" L



36651-CGM
1 3/4" L | 1 3/16" PROJ



36652-CGM
1 3/8" L | 1" PROJ



36653-CGM
1 3/8" L | 5/16" PROJ



AVAILABLE FINISHES



GRACE REVITALIZE



36628-BBZ
1 3/8" DIA
1 3/16" PROJ



36629-BBZ
1 3/4" DIA
1 3/8" PROJ



53013-ORB
3" C/C | 3 3/8" L



55243-ORB
96MM C/C | 4 1/5" L



55244-ORB
128MM C/C | 5 1/2" L



55245-ORB
160MM C/C | 6 7/8" L



GRANBY



HIGHLAND RIDGE

AVAILABLE FINISHES



55311-PN
35MM L | 1 1/7" PROJ



55312-PN
28MM DIA | 1 1/5" PROJ



55315-PN
1 3/8" L
1 5/16" PROJ

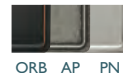

55316-PN
3" C/C | 4 1/3" L



55317-PN
96MM C/C | 5 1/6" L



55319-PN
128MM C/C | 6 2/3" L



55321-PN
160MM C/C | 8 4/7" L



55322-PN
8" C/C | 10 1/2" L



55323-PN
12" C/C | 15 1/3" L



55324-PN
18" C/C | 20 7/8" L





1584-ORB
3" C/C | 4 1/8" L



FB ORB G10



1585-ORB
1 1/4" DIA
1" PROJ



FB ORB G10



1784-ORB
96MM C/C | 4 7/8" L



ORB G10



1586-ORB
1 3/8" DIA
1" PROJ



FB ORB ART WID WN G10



1785-ORB
128MM C/C | 6 1/8" L



ORB G10



1586-2-ORB
1 3/4" DIA
1 1/4" PROJ



FB ORB WN G10



1590-ORB
3" C/C | 5 5/8" L



FB ORB WID WN G10



1593-ORB
1 7/8" L | 1 1/16" PROJ



FB ORB G10

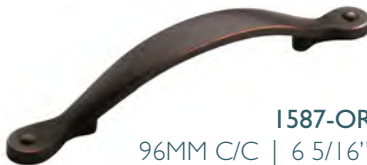

1587-ORB
96MM C/C | 6 5/16" L



FB ORB WN G10



1592-ORB
3" C/C | 4 1/4" L



FB ORB WID G10



1588-ORB
128MM C/C | 7 1/2" L



FB ORB WN G10

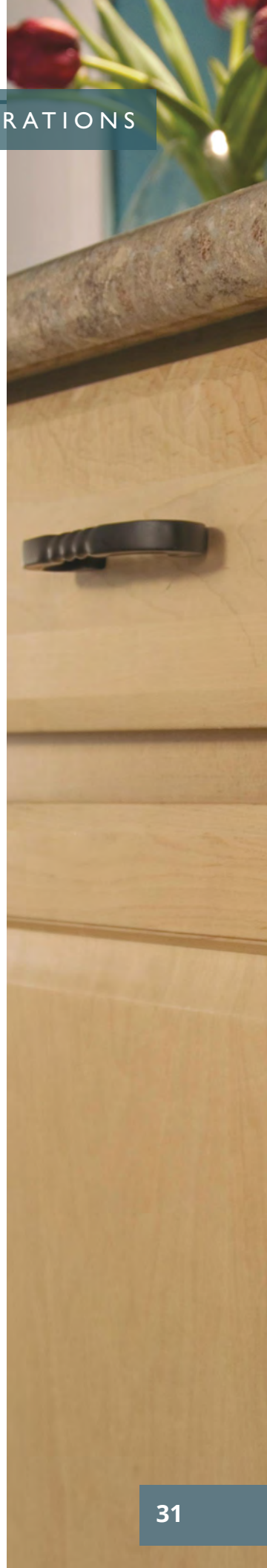

KAMARI

AVAILABLE FINISHES



36820-MB
1 3/16" DIA | 1" PROJ



36821-MB
1 3/16" DIA | 1" PROJ



36822-MB
3 3/4" C/C | 4 15/16" L



36823-MB
5 1/16" C/C | 6 3/16" L



36824-MB
6 5/16" C/C | 7 7/16" L



36825-MB
7 9/16" C/C | 8 3/4" L



36826-MB
10 1/16" C/C | 11 1/4" L



AVAILABLE FINISHES



53700-PN
1 1/4" DIA | 1 1/4" PROJ



53807-2-PN
1 5/8" DIA | 1 1/2" PROJ



53701-PN
3" C/C | 3 5/8" L



53702-PN
96MM C/C | 4 1/2" L



53801-PN
96MM C/C | 4 1/3" L



53802-PN
128MM C/C | 5 3/4" L



53803-PN
160MM C/C | 7" L



53804-PN
8" C/C | 8 7/8" L



53805-PN
12" C/C | 13" L



53806-PN
18" C/C | 19 1/4" L



LONDON

AVAILABLE
FINISH



36647-PNBBR
1 1/2" L | 1 9/16" PROJ



36648-PNBBR
3 3/4" C/C | 6 5/16" L



36649-PNBBR
5 1/16" C/C | 7 1/2" L



36650-PNBBR
6 5/16" C/C | 8 3/4" L



36651-PNBBR
8" C/C | 10 7/16" L



36664-PNBBR
10 1/16" C/C | 12 1/2" L

MANOR



26127-ORB
1 1/2" L
1 1/8" PROJ



ORB G10

MERGENCE

AVAILABLE FINISHES



36858-FBG10
96MM C/C | 4 15/16" L



36859-FBG10
128MM C/C | 6 3/16" L



36860-FBG10
160MM C/C | 7 7/16" L



36861-FBG10
224MM C/C | 9 15/16" L



36857-FBG10
1 3/8" DIA | 1" PROJ



AVAILABLE FINISHES



36578-ORB
76MM C/C | 3 3/8" L



36570-ORB
96MM C/C | 4 1/8" L



36571-ORB
128MM C/C | 5 7/16" L



36572-ORB
160MM C/C | 6 11/16" L



36909-ORB
224MM C/C | 9 13/16" L



36905-ORB
1 3/16" DIA | 1" PROJ

MONUMENT



MULHOLLAND

AVAILABLE FINISHES



53030-BBZ
3" C/C | 3 3/4" L



53029-BBZ
1 1/4" L | 1 1/8" PROJ



53031-BBZ
96MM C/C | 4 9/16" L



535342-BBZ
1 1/2" L | 1 1/8" PROJ



53529-BBZ
128MM C/C | 5 7/8" L



53530-BBZ
160MM C/C | 7 1/6" L



53531-BBZ
8" C/C | 9 1/6" L



53532-BBZ
12" C/C | 13 1/4" L



53533-BBZ
18" C/C | 19 1/4" L



MULINO

AVAILABLE FINISHES



36724-SCBN
128MM C/C | 6 1/4" L

36725-SCBN
192MM C/C | 8 3/4" L

36726-SCBN
256MM C/C | 11 1/4" L

36720-SCBN
2 3/8" L | 1 9/16" PROJ



NATURE'S SPLENDOR

1581-ORB
1 1/4" DIA
1 1/8" PROJ

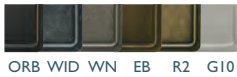

1583-ORB
1 7/8" L
1 1/16" PROJ



1580-ORB
3" C/C | 5 5/8" L

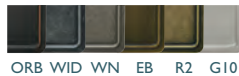

1582-ORB
3" C/C | 4 1/4" L



OBERON

36603-PN
1 3/8" DIA
1 3/16" PROJ



36604-PN
1 3/4" DIA
1 5/16" PROJ



36608-PNFA
1 3/8" DIA
1 3/16" PROJ



36609-PN
1 3/4" DIA
1 5/16" PROJ



OVERTON

AVAILABLE FINISHES

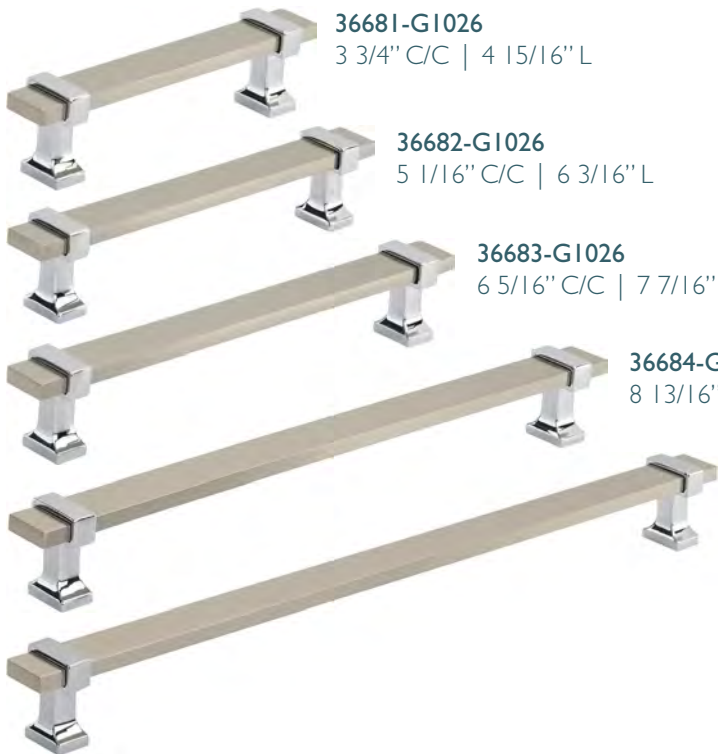

36681-G1026
3 3/4" C/C | 4 15/16" L

36682-G1026
5 1/16" C/C | 6 3/16" L

36683-G1026
6 5/16" C/C | 7 7/16" L

36684-G1026
8 13/16" C/C | 10" L

36685-G1026
11 5/16" C/C | 12 1/2" L



36680-G1026
2 5/8" L | 1 3/16" PROJ

PREMISE

AVAILABLE FINISHES

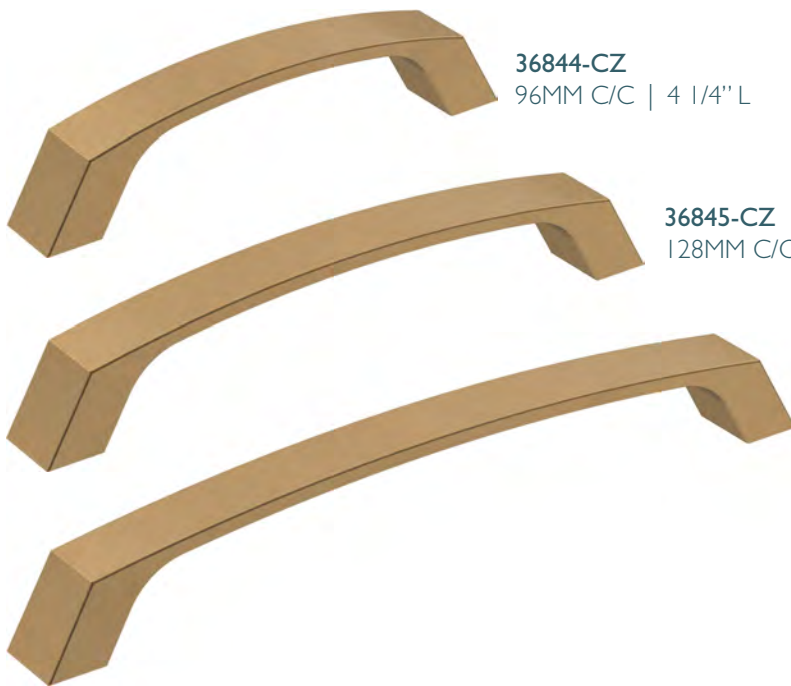

36844-CZ
96MM C/C | 4 1/4" L

36845-CZ
128MM C/C | 5 9/16" L

36846-CZ
160MM C/C | 6 13/16" L



36843-CZ
1 1/4" DIA | 1 1/16" PROJ



RADIUS

AVAILABLE FINISHES

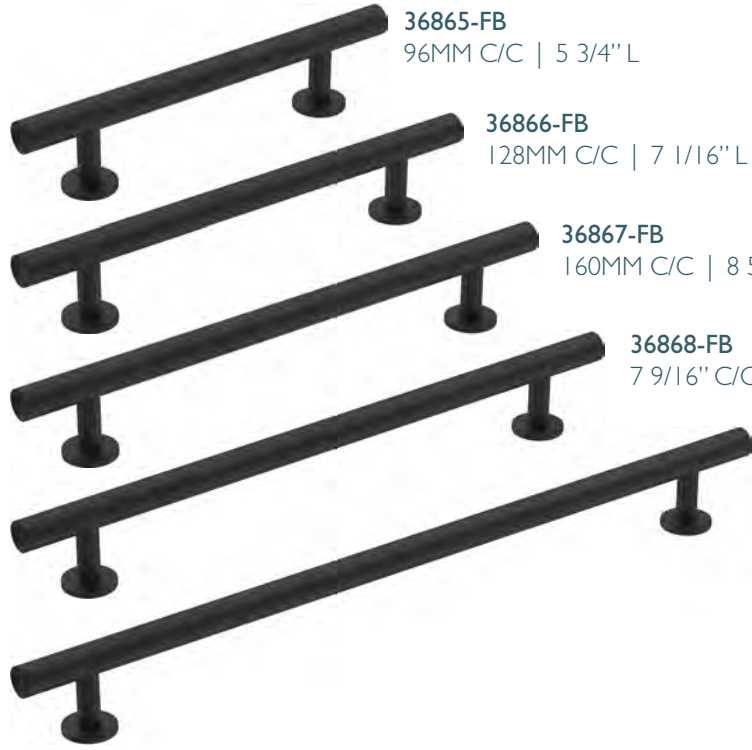

36865-FB
96MM C/C | 5 3/4" L

36866-FB
128MM C/C | 7 1/16" L

36867-FB
160MM C/C | 8 5/16" L

36868-FB
7 9/16" C/C | 9 9/16" L

36869-FB
10 1/16" C/C | 12 1/16" L



36864-FB
1 1/4" DIA | 1 1/16" PROJ

AVAILABLE FINISHES



53012-G10
1 1/4" DIA | 1 1/8" PROJ



21935-G10
3" C/C | 5" L



22094-G10
76MM C/C | 3 11/16" L



RAVINO

AVAILABLE FINISHES



36794-ORB
96MM C/C | 4 7/16" L

36795-ORB
128MM C/C | 5 11/16" L

36796-ORB
160MM C/C | 7" L



36793-ORB
1 1/4" DIA | 1 1/8" PROJ

RENOWN



REVITALIZE

AVAILABLE FINISHES



55340-ORB
1 1/4" L | 7/8" PROJ



55342-ORB
1 1/4" DIA | 1 1/4" PROJ



55341-ORB
1 1/4" DIA
1 1/8" PROJ



55343-ORB
3" C/C | A3 11/16" L



55344-ORB
96MM C/C | 4 5/16" L



55346-ORB
128MM C/C | 5 5/8" L

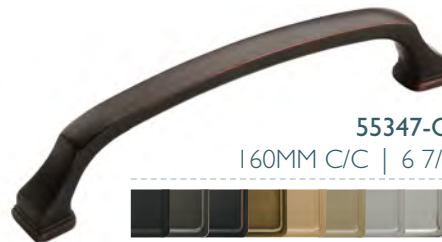

55347-ORB
160MM C/C | 6 7/8" L

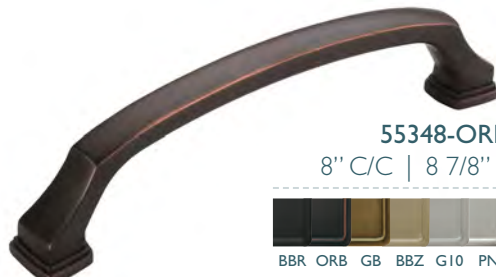

55348-ORB
8" C/C | 8 7/8" L



55349-ORB
12" C/C | 13" L



55350-ORB
18" C/C | 18 7/8" L



REVOLVE

AVAILABLE FINISHES



36852-26
96MM C/C | 4 1/4" L

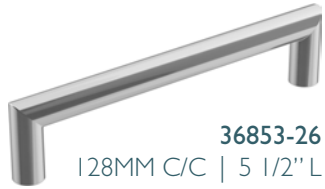

36853-26
128MM C/C | 5 1/2" L

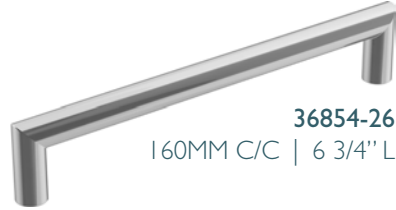

36854-26
160MM C/C | 6 3/4" L

RIFT

AVAILABLE FINISHES



36899-FB
96MM C/C | 4 1/4" L



36900-FB
128MM C/C | 5 1/2" L

RIVA



55364-GPH
3" C/C | 3 5/8" L



MB GPH BBZ G10 PN 26



55365-GPH
96MM C/C | 4 7/16" L



MB GPH BBZ G10 PN 26



55360-GPH
1 1/8" L
1" PROJ



ORB G10



55367-GPH
128MM C/C | 5 11/16" L



MB GPH BBZ G10 PN 26



55368-GPH
160MM C/C | 7 1/16" L



MB GPH BBZ G10 PN 26



55369-GPH
8" C/C | 9" L



ORB G10



55370-GPH
12" C/C | 13" L



ORB G10



55371-GPH
18" C/C | 19 1/8" L



ORB G10

ROCHDALE

AVAILABLE FINISHES



53710-G10
1 1/4" DIA
1 1/8" PROJ



53711-G10
3" C/C | 4" L



53712-G10
96MM C/C | 4 3/4" L



53713-G10
128MM C/C | 6" L



53714-G10
160MM C/C | 7 1/4" L



53715-G10
3" C/C | 4 1/2" L



53716-G10
96MM C/C | 5 3/8" L

SEA GRASS

AVAILABLE FINISHES



36617-BBZ
1 3/4" L | 1 5/16" PROJ



36614-BBZ
1 1/2" L | 1 3/16" PROJ



36615-BBZ
3" C/C | 3 7/8" L



36621-BBZ
3 3/4" C/C | 5" L



36622-BBZ
5 1/16" C/C | 6 1/4" L



36623-BBZ
6 5/16" C/C | 7 1/2" L

SEPARA

AVAILABLE FINISHES



36735-BBN
160MM C/C | 8 13/16" L

36736-BBN
8" C/C | 10 1/2" L

36737-BBN
10 1/16" C/C | 12 5/8" L



AVAILABLE FINISHES



ST. VINCENT



36646-PN
3" C/C | 5 7/16" L



36642-PN
2 1/2" L | 1 7/16" PROJ



36643-PN
3 3/4" C/C | 6 5/16" L



36644-PN
5 1/16" C/C | 7 1/2" L



36645-PN
6 5/16" C/C | 8 3/4" L



STATURE

AVAILABLE FINISHES



36891-26
76MM C/C | 3 3/4" L



36887-26
96MM C/C | 4 9/16" L



36888-26
128MM C/C | 5 13/16" L



36889-26
160MM C/C | 7 1/16" L



36890-26
224MM C/C | 9 9/16" L



22439-26
128MM C/C | 6 3/8" L



11287-26
1 1/4" L | 1 1/4" PROJ

STATUS

AVAILABLE FINISHES



36837-MB
96MM C/C | 4 9/16" L



36838-MB
128MM C/C | 5 13/16" L



36839-MB
160MM C/C | 7 1/16" L



36840-MB
224MM C/C | 9 5/8" L



36836-MB
2" L | 1 1/16" PROJ

STERLING TRADITIONS

AVAILABLE FINISH
ORB

1307-ORB
1 1/4" DIA
15/16" PROJ

1300-ORB
3" C/C | 5 1/4" L

1302-ORB
3" C/C | 5" L



AVAILABLE FINISHES
MB CZ G10 26

36894-CZ
96MM C/C | 4 9/16" L

36895-CZ
128MM C/C | 5 13/16" L

36896-CZ
160MM C/C | 7 1/16" L



36893-CZ
1 1/4" L | 1 3/16" PROJ

SURPASS



THE ANNIVERSARY COLLECTION

853-G9
1 3/16" DIA
1 1/16" PROJ



874-G9
3" C/C | 5" L



TRADITIONAL CLASSICS

55268-CBBZ
1 1/4" DIA
1 1/2" PROJ



55266-CG10
1" DIA
1 1/2" PROJ



14303-3G10
1 1/4" DIA
1 1/4" PROJ



TRANSCENDENT

AVAILABLE FINISHES



196732-MBSC
1 1/4" DIA | 7/8" PROJ



741416-MBSC
5/8" C/C | 3 3/16" L



741496-MBSC
3 3/4" C/C | 6 15/16" L



7414128-MBSC
5 1/16" C/C | 8 3/16" L



7414160-MBSC
6 5/16" C/C | 9 7/16" L



7414192-MBSC
7 9/16" C/C | 10 11/16" L



7414256-MBSC
10 1/16" C/C | 13 3/16" L



7414320-MBSC
12 5/8" C/C | 15 3/4" L



UPRISE

AVAILABLE FINISHES



36917-G10
96MM C/C | 6 5/8" L

36918-G10
128MM C/C | 7 7/8" L

36919-G10
160MM C/C | 10 5/8" L

36920-G10
224MM C/C | 11 15/16" L



AVAILABLE FINISHES



URBANITE

77896-BGLWHT
3 3/4" C/C | 6 1/2" L

778128-BGLWHT
5 1/16" C/C | 7 13/16" L

778160-BGLWHT
6 5/16" C/C | 9 1/16" L

778192-BGLWHT
7 9/16" C/C | 10 1/4" L

778256-BGLWHT
10 1/16" C/C | 12 3/4" L



67-BGLWHT
2 5/8" L | 1 3/16" PROJ



VAILE



AVAILABLE FINISHES

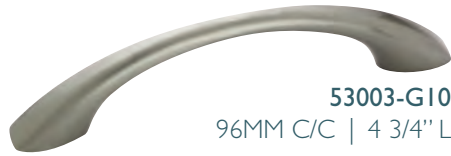

53003-G10
96MM C/C | 4 3/4" L



53014-G10
1 3/8" L | 1 1/2" PROJ

VERSA



AVAILABLE FINISHES



36912-FB
96MM C/C | 4 11/16" L



36913-FB
128MM C/C | 5 15/16" L



36914-FB
160MM C/C | 7 3/16" L



36915-FB
224MM C/C | 9 3/4" L



36904-FB
1 3/8" DIA | 1" PROJ

VILLE



AVAILABLE FINISHES



36775-26
96MM C/C | 4 5/8" L



36776-26
128MM C/C | 5 7/8" L



36777-26
160MM C/C | 7 1/8" L



36774-26
1 1/8" DIA | 1 1/16" PROJ

WESTERLY

AVAILABLE FINISHES

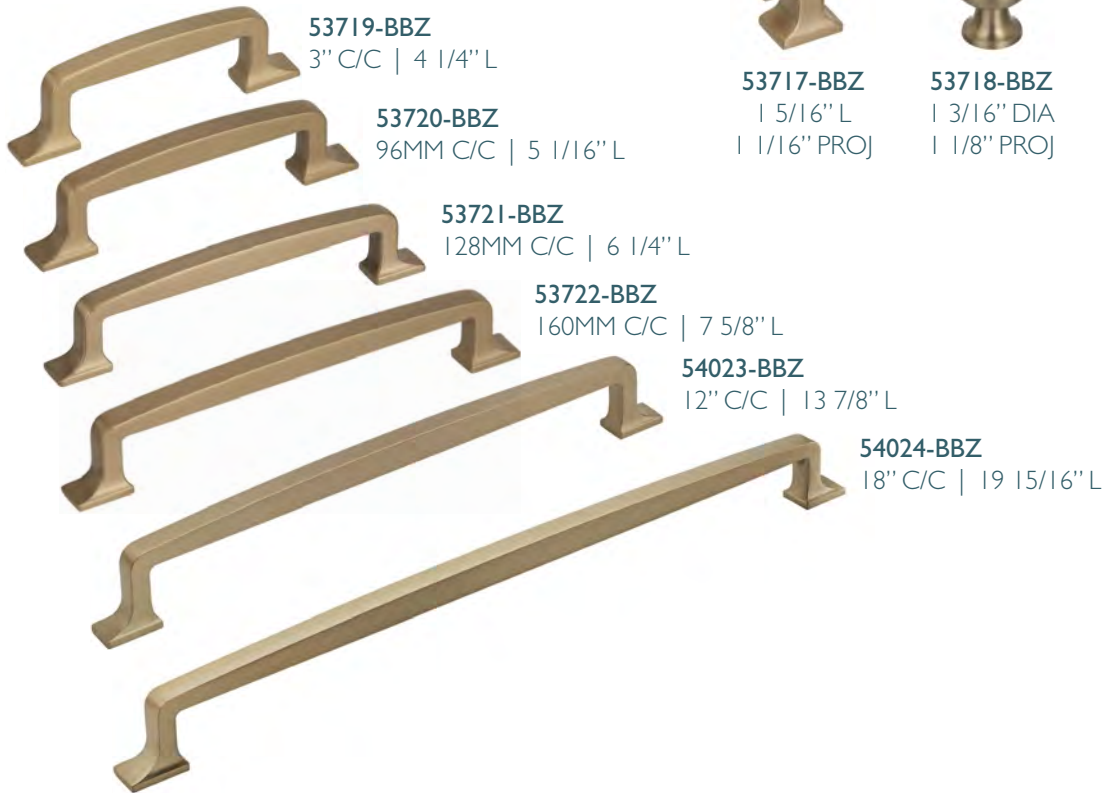

53719-BBZ
3" C/C | 4 1/4" L

53720-BBZ
96MM C/C | 5 1/16" L

53721-BBZ
128MM C/C | 6 1/4" L

53722-BBZ
160MM C/C | 7 5/8" L

54023-BBZ
12" C/C | 13 7/8" L

54024-BBZ
18" C/C | 19 15/16" L



53717-BBZ
1 5/16" L
1 1/16" PROJ



53718-BBZ
1 3/16" DIA
1 1/8" PROJ



AVAILABLE FINISHES



WINSOME

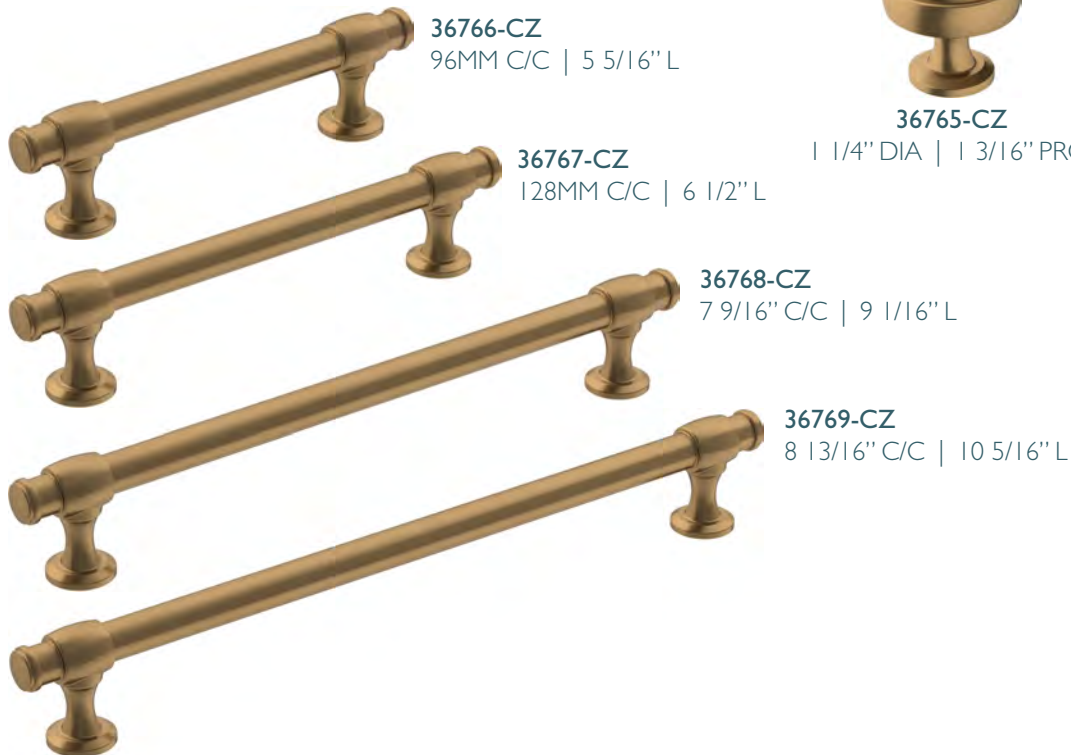

36766-CZ
96MM C/C | 5 5/16" L

36767-CZ
128MM C/C | 6 1/2" L

36768-CZ
7 9/16" C/C | 9 1/16" L

36769-CZ
8 13/16" C/C | 10 5/16" L



36765-CZ
1 1/4" DIA | 1 3/16" PROJ



APPOINT

AVAILABLE FINISHES



36070-G10
1 7/8" L
2 1/2" PROJ



36071-G10
7 1/16" L
2 1/2" PROJ



36072-G10
7 1/16" L
2 1/16" PROJ



36073-G10
18" C/C | 19 1/4" L

36074-G10
24" C/C | 25 1/4" L

ARRONDI

AVAILABLE FINISHES



26542-BBZ
2 1/16" L
2 1/16" PROJ



26540-BBZ
7 5/16" L
3 1/16" PROJ



26541-BBZ
6 3/8" L
2 1/16" PROJ



26546-BBZ
9" C/C | 11 5/8" L

26543-BBZ
18" C/C | 21" L

26544-BBZ
24" C/C | 27" L

BLACKROCK

AVAILABLE FINISHES



36000-ORB
3 9/16" L
2 1/8" PROJ



36001-ORB
9 5/16" L
2 13/16" PROJ



36002-ORB
6 13/16" L
2 7/8" PROJ



36003-ORB
18" C/C | 19 7/8" L

36004-ORB
24" C/C | 25 7/8" L

DAVENPORT

AVAILABLE FINISHES



36050-MB
2 15/16" L
3" PROJ

36051-MB
8 13/16" L
3" PROJ

36052-MB
5 1/4" L
3" PROJ

36053-MB
18" C/C | 20 5/16" L

36054-MB
24" C/C | 26 5/16" L



AVAILABLE FINISHES



26613-PNGM
4 1/2" L
2 9/16" PROJ

26617-PNGM
5 7/8" L
3 3/16" PROJ

26612-PNGM
5 1/4" L
2 9/16" PROJ

26614-PNGM
18" C/C | 22 11/16" L

26615-PNGM
24" C/C | 28 5/8" L

ESQUIRE



AVAILABLE FINISHES



36060-CCZ
2 15/16" L
2 1/2" PROJ

36061-CCZ
7 1/16" L
3 1/16" PROJ

36062-CCZ
5 7/16" L
3 1/16" PROJ

36065-CCZ
8" C/C | 10 1/4" L

36063-CCZ
18" C/C | 20 1/4" L

36064-CCZ
24" C/C | 26 1/4" L

GLACIO

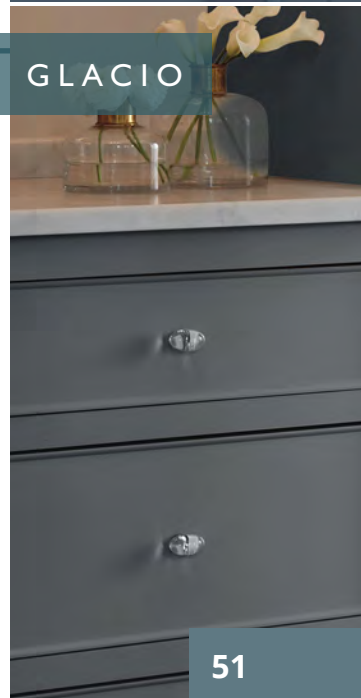

HIGHLAND RIDGE

AVAILABLE FINISHES



36010-26
2 5/8" L
2 1/2" PROJ



36011-26
10 5/8" L
2 13/16" PROJ



36012-26
7 7/16" L
3" PROJ



36013-26
18" C/C | 20 13/16" L



36014-26
24" C/C | 26 13/16" L

MONUMENT

AVAILABLE FINISHES



36080-MB
7/8" L
2 3/8" PROJ



36081-MB
5 7/8" L
2 3/4" PROJ



36082-MB
6 1/2" L
2 3/8" PROJ



36083-MB
18" C/C | 18 7/8" L



36084-MB
24" C/C | 24 7/8" L

MULHOLLAND

AVAILABLE FINISHES



36020-G10
4 1/4" L
3 5/8" PROJ



36021-G10
8 13/16" L
2 13/16" PROJ



36022-G10
5 3/4" L
2 5/16" PROJ



36023-G10
18" C/C | 19 13/16" L



36024-G10
24" C/C | 25 3/4" L

REVITALIZE



36030-BBZ
2 1/8" L
2 3/8" PROJ

36031-BBZ
7 7/8" L
3 1/16" PROJ

36032-BBZ
6 3/8" L
2 13/16" PROJ

36033-BBZ
18" C/C | 19 3/4" L

36034-BBZ
24" C/C | 25 3/4" L



ST. VINCENT

36040-CZ
2 1/16" L
2 1/16" PROJ

36041-CZ
7 5/16" L
3 1/16" PROJ

36042-CZ
6 3/8" L
2 1/16" PROJ

36043-CZ
18" C/C | 21" L

36044-CZ
24" C/C | 26 8/9" L



STATURE

36090-G10
2 1/4" L
2 1/2" PROJ

36091-G10
7 1/16" L
2 5/8" PROJ

36092-G10
7 9/16" L
2 5/8" PROJ

36093-G10
18" C/C | 20 1/4" L

36094-G10
24" C/C | 26 1/4" L

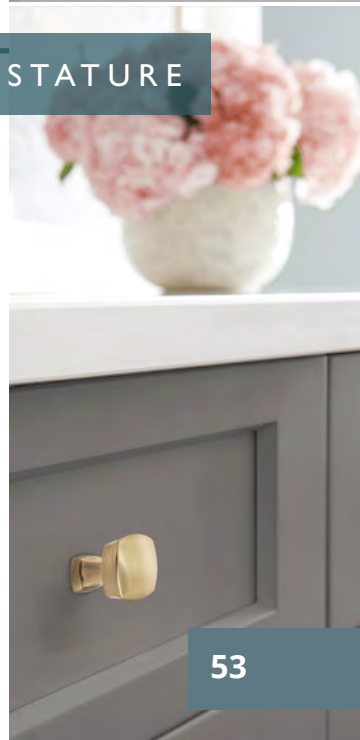

BACKPLATES

AVAILABLE FINISHES



G10 ORB



19208-ORB
3" C/C | 5 5/8" L

MAGNETIC CATCHES

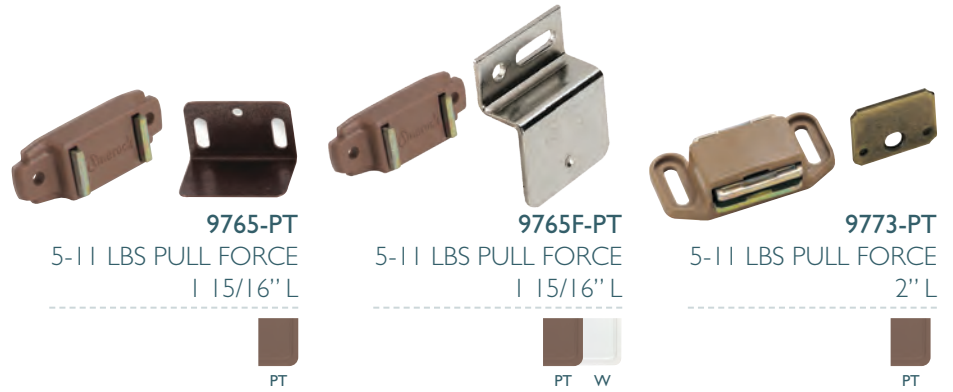

9765-PT
5-11 LBS PULL FORCE
1 15/16" L



PT

9765F-PT
5-11 LBS PULL FORCE
1 15/16" L



PT W

9773-PT
5-11 LBS PULL FORCE
2" L



PT

HINGES

AVAILABLE FINISHES



14 BB FB G10 ORB W WI WN



7550-WI
2 1/4" L
1/2" OVERLAY

HINGES

AVAILABLE FINISHES



BB G10



7566-G10
2 1/4" L
1/4" OVERLAY

HINGES

AVAILABLE FINISHES



BB G10 ORB WN



7565-G10
2 1/4" L
3/8" INSET

HINGES

AVAILABLE FINISHES



AE FB G10 ORB



3175-TB-ORB
2 1/2" L

HINGES

AVAILABLE FINISHES



FB G10 ORB



3180-TB-FB
2 1/2" L

HINGES

AVAILABLE FINISHES



14 3 G10 BB WI ORB BK



7139-14
2 3/4" L
VARIABLE OVERLAY

HINGES

AVAILABLE FINISHES



G10 ORB



3175-TM-G10
2 7/8" L

HINGES

AVAILABLE FINISHES



G10 G9



3180-TM-G9
2 3/4" L

HINGES

AVAILABLE FINISHES



BB G10 ORB



7128-BB
2 3/4" L
3/8" INSET

H-Select

H-Select

COLORADO - NEW!

H-SELECT



KP92925-SN
SATIN NICKEL
1 5/16" DIA
1 1/8" PROJ



KP92925-BK
MATTE BLACK
1 5/16" DIA
1 1/8" PROJ



KP92925-10B
OIL RUBBED BRONZE
1 5/16" DIA
1 1/8" PROJ



KP92925-RG
ROSE GOLD
1 5/16" DIA
1 1/8" PROJ



KP92925-DP
DARK PEWTER
1 5/16" DIA
1 1/8" PROJ



KP92925-PC
POLISHED CHROME
1 5/16" DIA
1 1/8" PROJ



KP97723-SN
SATIN NICKEL
1 1/8" DIA
1 1/8" PROJ



KP97723-BK
MATTE BLACK
1 1/8" DIA
1 1/8" PROJ



KP97723-10B
OIL RUBBED BRONZE
1 1/8" DIA
1 1/8" PROJ



KP97723-RG
ROSE GOLD
1 1/8" DIA
1 1/8" PROJ



KP97723-DP
DARK PEWTER
1 1/8" DIA
1 1/8" PROJ



KP97723-PC
POLISHED CHROME
1 1/8" DIA
1 1/8" PROJ

| ITEM | MSRP |
|---------------|---------|
| K92836 | \$8.30 |
| K92837 | \$9.72 |
| K92838 | \$12.14 |
| K92925 | \$6.30 |
| K94723 | \$7.44 |



K92836-SN
SATIN NICKEL
4 5/8" L
96MM C/C



K92836-10B
OIL RUBBED BRONZE
4 5/8" L
96MM C/C



K92836-DP
DARK PEWTER
4 5/8" L
96MM C/C



K92837-SN
SATIN NICKEL
5 7/8" L
128MM C/C



K92837-10B
OIL RUBBED BRONZE
5 7/8" L
128MM C/C



K92837-DP
DARK PEWTER
5 7/8" L
128MM C/C



K92838-SN
SATIN NICKEL
7 1/8" L
160MM C/C



K92838-10B
OIL RUBBED BRONZE
7 1/8" L
160MM C/C



K92838-DP
DARK PEWTER
7 1/8" L
160MM C/C



K92836-BK
MATTE BLACK
4 5/8" L
96MM C/C



K92836-RG
ROSE GOLD
4 5/8" L
96MM C/C



K92836-PC
POLISHED CHROME
4 5/8" L
96MM C/C



K92837-BK
MATTE BLACK
5 7/8" L
128MM C/C



K92837-RG
ROSE GOLD
5 7/8" L
128MM C/C



K92837-PC
POLISHED CHROME
5 7/8" L
128MM C/C



K92838-BK
MATTE BLACK
7 1/8" L
160MM C/C



K92838-RG
ROSE GOLD
7 1/8" L
160MM C/C



K92838-PC
POLISHED CHROME
7 1/8" L
160MM C/C

H-Select

STOCKPORT



K3219-96-ORB
OIL RUBBED BRONZE
4 5/8" L
96MM C/C

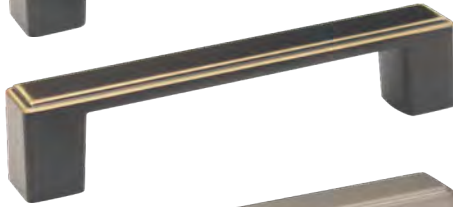

K3219-96-BYAB
BLACK YELLOW ANTIQUE BRASS
4 5/8" L
96MM C/C



K3219-96-BRN
BRUSHED NICKEL
4 5/8" L
96MM C/C

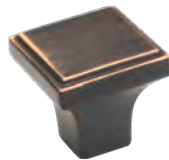

K3219-ORB
OIL RUBBED BRONZE
1 1/16" DIA
1" PROJ

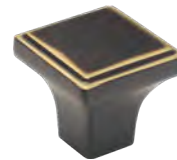

K3219-BYAB
BLACK YELLOW ANTIQUE BRASS
1 1/16" DIA
1" PROJ

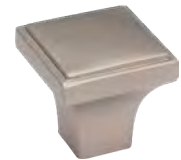

K3219-BRN
BRUSHED NICKEL
1 1/16" DIA
1" PROJ

| ITEM | MSRP |
|----------------------|--------|
| K3219-ORB | \$5.50 |
| K3219-BYAB | \$5.50 |
| K3219-BRN | \$5.50 |
| K3219-96-ORB | \$9.00 |
| K3219-96-BYAB | \$9.00 |
| K3219-96-BRN | \$9.00 |

ROWVILLE



K3235-96-BYAB
BLACK YELLOW ANTIQUE BRASS
5 1/8" L
96MM C/C



K3235-128-BYAB
BLACK YELLOW ANTIQUE BRASS
6 3/8" L
128MM C/C



K3235-96-ORB
OIL RUBBED BRONZE
5 1/8" L
96MM C/C



K3235-128-ORB
OIL RUBBED BRONZE
6 3/8" L
128MM C/C



K3235-96-BRN
BRUSHED NICKEL
5 1/8" L
96MM C/C



K3235-128-BRN
BRUSHED NICKEL
6 3/8" L
128MM C/C



K3235-96-BL
BLACK
5 1/8" L
96MM C/C



K3235-128-BL
BLACK
6 3/8" L
128MM C/C

| ITEM | MSRP |
|-----------------------|--------|
| K3235-96-BYAB | \$8.50 |
| K3235-128-BYAB | \$9.00 |
| K3235-96-ORB | \$8.50 |
| K3235-128-ORB | \$9.00 |
| K3235-96-BRN | \$8.50 |
| K3235-128-BRN | \$9.00 |
| K3235-96-BL | \$8.50 |
| K3235-128-BL | \$9.00 |

H-SELECT

H-Select

CHEYENNE



K3417-ORB
OIL RUBBED BRONZE
1 1/4" DIA
1" PROJ



K3417-BB
BURNISHED BRASS
1 1/4" DIA
1" PROJ



K3417-WN
WEATHERED NICKEL
1 1/4" DIA
1" PROJ



K3417-GOLD
GOLD
1 1/4" DIA
1" PROJ

| ITEM | MSRP |
|------------|--------|
| K3417-ORB | \$4.50 |
| K3417-BB | \$4.50 |
| K3417-WN | \$4.50 |
| K3417-GOLD | \$4.50 |

DENALI



K4618-BN
BRUSHED NICKEL
1" DIA
1 3/16" PROJ



K4618-SAB
SABLE
1" DIA
1 3/16" PROJ



K4618-HB
HONEY BRONZED
1" DIA
1 3/16" PROJ

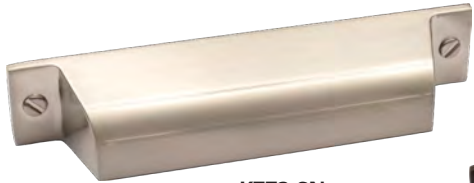

K773-SN
SATIN NICKEL
5 1/4" L
96MM C/C



K773-SAB
SABLE
5 1/4" L
96MM C/C



K773-HB
HONEY BRONZED
5 1/4" L
96MM C/C

| ITEM | MSRP |
|-----------|--------|
| K4618-BN | \$6.50 |
| K4618-SAB | \$6.50 |
| K4618-HB | \$6.50 |
| K773-SN | \$8.50 |
| K773-SAB | \$8.50 |
| K773-HB | \$8.50 |

INSPIRATION RING



K4118-WN
WEATHERED NICKEL
2" DIA
1 1/2" PROJ



K4118-BB
BURNISHED BRASS
2" DIA
1 1/2" PROJ



K4118-ORB
OIL RUBBED BRONZE
2" DIA
1 1/2" PROJ

| ITEM | MSRP |
|-----------|--------|
| K4118-WN | \$3.50 |
| K4118-BB | \$3.50 |
| K4118-ORB | \$3.50 |

H-Select

CLASSIC RING



K4318-BRPW
BRUSHED PEWTER
2" DIA
1" PROJ



K4318-BN
BRUSHED NICKEL
2" DIA
1" PROJ



K4318-AE
ANTIQUENGLISH
2" DIA
1" PROJ



K4318-ORB
OIL RUBBED BRONZE
2" DIA
1" PROJ

| ITEM | MSRP |
|-------------------|--------|
| K4318-BRPW | \$4.00 |
| K4318-BN | \$4.00 |
| K4318-ORB | \$4.00 |
| K4318-AE | \$4.00 |

LINCOLN



K4218-BB
BURNISHED BRASS
7/8" DIA
3/4" PROJ



K4218-WN
WEATHERED NICKEL
7/8" DIA
3/4" PROJ



K4218-ORB
OIL RUBBED BRONZE
7/8" DIA
3/4" PROJ

| ITEM | MSRP |
|------------------|--------|
| K4218-BB | \$3.90 |
| K4218-WN | \$3.90 |
| K4218-ORB | \$3.90 |

MISC. KNOBS



K2302-AS
ANTIQUENICKEL
1 1/2" DIA
1 1/8" PROJ



K4418-BN
BRUSHED NICKEL
3/4" DIA
15/16" PROJ



K3217-DACM
DARK ANTIQUE
COPPER MACHINED
1 1/4" DIA
1 1/8" PROJ



K4438-WI
WROUGHT IRON
1 1/2" DIA
1 1/4" PROJ

| ITEM | MSRP |
|-------------------|--------|
| K2302-AS | \$3.80 |
| K4418-BN | \$3.00 |
| K3217-DACM | \$4.70 |
| K4438-WI | \$5.50 |

BOW



K2040-BL
BLACK
1 1/4" DIA
1 1/4" PROJ



K2040-OB
OIL BRONZE
1 1/4" DIA
1 1/4" PROJ



K2040-SN
SATIN NICKEL
1 1/4" DIA
1 1/4" PROJ



K2335-OB
OIL BRONZE
1 1/4" DIA
1" PROJ



K2335-WN
WEATHERED NICKEL
1" DIA
3/4" PROJ



K2029-BL
BLACK
6 1/8" L
128MM C/C



K2029-LAP
LIGHT ANTIQUE PEWTER
6 1/8" L
128MM C/C



K2029-OB
OIL BRONZE
6 1/8" L
128MM C/C



K2029-SN
SATIN NICKEL
6 1/8" L
128MM C/C



K2029-ABMD
ANTIQUENICKEL MACHINED DULL
6 1/8" L
128MM C/C

| ITEM | MSRP |
|-------------------|--------|
| K2029-ABMD | \$6.50 |
| K2029-BL | \$6.50 |
| K2029-LAP | \$6.50 |
| K2029-OB | \$6.50 |
| K2029-SN | \$6.50 |
| K2040-BL | \$3.90 |
| K2040-OB | \$3.90 |
| K2040-SN | \$3.90 |
| K2335-OB | \$5.00 |
| K2335-WN | \$5.00 |

AMERICANA

H-SELECT



K88
LANCASTER ANTIQUE
1 1/4" DIA
3/4" PROJ



K88-B
PEWTER
1 1/4" DIA
3/4" PROJ



K282-AN
ANTIQUÉ NICKEL
2 1/8" DIA
7/8" PROJ



K330-AN
ANTIQUÉ NICKEL
7/8" DIA
1 1/8" PROJ



K87
LANCASTER ANTIQUE
4 1/8" L
3" C/C



K87-B
PEWTER
4 1/8" L
3" C/C



K87-SN
SATIN NICKEL
4 1/8" L
3" C/C

| ITEM | MSRP |
|---------|--------|
| K87 | \$5.00 |
| K87-B | \$5.00 |
| K87-SN | \$5.00 |
| K88 | \$4.00 |
| K88-B | \$4.00 |
| K282-AN | \$6.70 |
| K330-AN | \$4.00 |

BELL IRON 1



K117-ABMD
ANTIQUÉ BRASS
MACHINED DULL
1 1/4" DIA
15/16" PROJ



K117-DACM
DARK BRUSHED
COPPER MACHINED
1 1/4" DIA
15/16" PROJ



K527-ABMD
ANTIQUÉ BRASS MACHINED DULL
4 1/2" L
96MM C/C



K117-DBAC
DARK BRUSHED
ANTIQUÉ COPPER
1 1/4" DIA
15/16" PROJ



K117-SIM
PEWTER
1 1/4" DIA
15/16" PROJ



K527-DACM
DARK BRUSHED COPPER MACHINED
4 1/2" L
96MM C/C



K527-DBAC
DARK BRUSHED ANTIQUÉ COPPER
4 1/2" L
96MM C/C



K527-SIM
PEWTER
4 1/2" L
96MM C/C

| ITEM | MSRP |
|-----------|--------|
| K117-ABMD | \$4.36 |
| K117-DACM | \$4.36 |
| K117-DBAC | \$4.36 |
| K117-SIM | \$4.36 |
| K527-ABMD | \$8.66 |
| K527-DACM | \$8.66 |
| K527-DBAC | \$8.66 |
| K527-SIM | \$8.66 |

BELL IRON 2



K6303-RG
ROSE GOLD
1 3/8" DIA
1" PROJ



K6303-ABMD
ANTIQUÉ BRASS
MACHINED DULL
1 3/8" DIA
1" PROJ



K6303-DMAC
DARK MACHINED
ANTIQUÉ COPPER
1 3/8" DIA
1" PROJ



K6373-ABMD
ANTIQUÉ BRASS MACHINED DULL
4 1/2" L • 96MM C/C



K6303-MB
MATTE BLACK
1 3/8" DIA
1" PROJ



K6303-DACM
DARK BRUSHED
COPPER MACHINED
1 3/8" DIA • 1" PROJ



K6303-SIM
PEWTER
1 3/8" DIA
1" PROJ



K6373-DMAC
DARK MACHINED ANTIQUÉ COPPER
4 1/2" L • 96MM C/C



K6373-DACM
DARK BRUSHED COPPER MACHINED
4 1/2" L • 96MM C/C



K6373-RG
ROSE GOLD
4 1/2" L • 96MM C/C



K6373-MB
MATTE BLACK
4 1/2" L • 96MM C/C



K6373-SIM
PEWTER
4 1/2" L • 96MM C/C

| ITEM | MSRP |
|------------|--------|
| K6303-ABMD | \$5.78 |
| K6303-DACM | \$5.78 |
| K6303-DMAC | \$5.78 |
| K6303-SIM | \$5.78 |
| K6303-RG | \$5.90 |
| K6303-MB | \$5.90 |
| K6373-ABMD | \$7.18 |
| K6373-DACM | \$7.18 |
| K6373-DMAC | \$7.18 |
| K6373-SIM | \$7.18 |
| K6373-DBAC | \$7.18 |
| K6373-SN | \$7.18 |
| K6373-RG | \$7.18 |
| K6373-MB | \$7.18 |

H-Select

ADVANTAGE



K107-AEM
ANTIQUE ENGLISH
1 1/4" DIA
1" PROJ



K107-ASM
ANTIQUE SILVER
MACHINED
1 1/4" DIA
1" PROJ



K107-DBAC
DARK BRUSHED
ANTIQUÉ COPPER
1 1/4" DIA
1" PROJ



K107-SN
SATIN NICKEL
1 1/4" DIA
1" PROJ



K3898-DBAC
DARK BRUSHED
ANTIQUÉ COPPER
1 1/8" DIA
1 1/4" PROJ



K3898-DBN
BRIGHT NICKEL
BRUSHED DULL
1 1/8" DIA
1 1/4" PROJ



K3208-DBAC
DARK BRUSHED
ANTIQUÉ COPPER
4 1/4" L
3" C/C



K3208-SN
SATIN NICKEL
4 1/4" L
3" C/C



K3108-DBAC
DARK BRUSHED
ANTIQUÉ COPPER
5 1/4" L
3" C/C



K516-ASM
ANTIQUÉ SILVER
MACHINED
5 1/2" L
3" C/C



K3108-SN
SATIN NICKEL
5 1/4" L
3" C/C



K516-SN
SATIN NICKEL
5 1/2" L
3" C/C



K516-AEM
ANTIQUÉ ENGLISH
5 1/2" L
3" C/C



K516-DBAC
DARK BRUSHED
ANTIQUÉ COPPER
5 1/2" L
3" C/C



K3899-DBN
BRIGHT NICKEL
BRUSHED DULL
5 1/4" L
3" C/C



K3899-DBAC
DARK BRUSHED
ANTIQUÉ COPPER
5 1/4" L
3" C/C

| ITEM | MSRP |
|-------------------|--------|
| K107-AEM | \$3.98 |
| K107-ASM | \$3.98 |
| K107-DBAC | \$3.98 |
| K107-SN | \$3.98 |
| K516-AEM | \$4.10 |
| K516-ASM | \$4.10 |
| K516-DBAC | \$4.10 |
| K516-SN | \$4.10 |
| K3108-DBAC | \$5.00 |
| K3108-SN | \$5.00 |
| K3208-DBAC | \$5.00 |
| K3208-SN | \$5.00 |
| K3898-DBAC | \$3.78 |
| K3898-DBN | \$3.78 |
| K3899-DBAC | \$3.50 |
| K3899-DBN | \$3.50 |

H-SELECT

BOUNTIFUL



K6102-ORB
OIL-RUBBED BRONZE
1 1/4" DIA
1 1/8" PROJ



K6102-SN
SATIN NICKEL
1 1/4" DIA
1 1/8" PROJ



K6765-ORB
OIL-RUBBED BRONZE
5" L
3" C/C



K6765-SN
SATIN NICKEL
5" L
3" C/C

| ITEM | MSRP |
|------------------|--------|
| K6102-ORB | \$5.50 |
| K6102-SN | \$5.50 |
| K6765-ORB | \$5.90 |
| K6765-SN | \$5.90 |

H-Select

BASKET WEAVE



K3062-ORB
OIL-RUBBED BRONZE
1 1/4" DIA
1" PROJ



K3062-SN
SATIN NICKEL
1 1/4" DIA
1" PROJ



K3062-SI
PEWTER
1 1/4" DIA
1" PROJ

| ITEM | MSRP |
|------------------|--------|
| K3062-ORB | \$5.40 |
| K3062-SI | \$5.40 |
| K3062-SN | \$5.40 |
| K3063-ORB | \$6.50 |
| K3063-SI | \$6.50 |
| K3063-SN | \$6.50 |



K3063-ORB
OIL-RUBBED BRONZE
4 3/4" L
3" C/C



K3063-SN
SATIN NICKEL
4 3/4" L
3" C/C



K3063-SI
PEWTER
4 3/4" L
3" C/C

H-SELECT

COUNTRY TIME



K6060-DBAC
DARK BRUSHED
ANTIQUÉ COPPER
1 1/4" DIA
1 3/8" PROJ



K6060-DBN
BRIGHT NICKEL
BRUSHED DULL
1 1/4" DIA
1 3/8" PROJ



Z117-DACM
DARK BRUSHED
COPPER MACHINED
1 1/4" DIA
1" PROJ



Z117-DBN
BRIGHT NICKEL
BRUSHED DULL
1 1/4" DIA
1" PROJ



Z117-SIM
PEWTER
1 1/4" DIA
1" PROJ

| ITEM | MSRP |
|-------------------|--------|
| K260-DBAC | \$5.00 |
| K260-DBN | \$5.00 |
| K6060-DBAC | \$5.00 |
| K6060-DBN | \$5.00 |
| Z117-DACM | \$4.70 |
| Z117-DBN | \$4.70 |
| Z117-SIM | \$4.70 |



K260-DBAC
DARK BRUSHED ANTIQUÉ COPPER
3 3/4" L
3" C/C



K260-DBN
BRIGHT NICKEL BRUSHED DULL
3 3/4" L
3" C/C

HARVEST



K6464-DBAC
DARK BRUSHED
ANTIQUÉ COPPER
1 1/4" DIA
1 1/8" PROJ



K6464-SN
SATIN NICKEL
1 1/4" DIA
1 1/8" PROJ

| ITEM | MSRP |
|-------------------|--------|
| K6464-DBAC | \$5.70 |
| K6464-SN | \$5.70 |
| K6465-DBAC | \$6.90 |
| K6465-SN | \$6.90 |



K6465-DBAC
DARK BRUSHED ANTIQUÉ
COPPER
5 5/8" L
3" C/C



K6465-SN
SATIN NICKEL
5 5/8" L
3" C/C

H-Select

FLAIR



K196-ACM
ANTIQUE COPPER MACHINED
2 1/4" L
1 1/4" C/C



K196-DBAC
DARK BRUSHED ANTIQUE COPPER
2 1/4" L
1 1/4" C/C



K195-ACM
ANTIQUE COPPER MACHINED
4 7/8" L
96MM C/C



K195-DBAC
DARK BRUSHED ANTIQUE COPPER
4 7/8" L
96MM C/C

| ITEM | MSRP |
|-----------|--------|
| K195-ACM | \$6.98 |
| K195-DBAC | \$6.98 |
| K196-ACM | \$4.60 |
| K196-DBAC | \$4.60 |

DELGADO



K519-ABSB
ANTIQUE BRUSHED
SATIN BRASS
1 1/2" L
1 1/4" PROJ



K519-DBAC
DARK BRUSHED
ANTIQUÉ COPPER
1 1/2" L
1 1/4" PROJ



K519-DBN
BRIGHT NICKEL
BRUSHED DULL
1 1/2" L
1 1/4" PROJ

| ITEM | MSRP |
|-------------|---------|
| K519-96ABSB | \$13.00 |
| K519-96DBAC | \$13.00 |
| K519-96DBN | \$13.00 |
| K519-ABSB | \$7.00 |
| K519-DBAC | \$7.00 |
| K519-DBN | \$7.00 |



K519-96ABSB
ANTIQUE BRUSHED SATIN BRASS
4 1/4" L
96MM C/C



K519-96DBAC
DARK BRUSHED ANTIQUÉ COPPER
4 1/4" L
96MM C/C



K519-96DBN
BRIGHT NICKEL BRUSHED DULL
4 1/4" L
96MM C/C

ROCHESTER



K155-ABSB
ANTIQUE BRUSHED
SATIN BRASS
1 1/8" DIA
15/16" PROJ

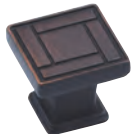

K155-DBAC
DARK BRUSHED
ANTIQUÉ COPPER
1 1/8" DIA
15/16" PROJ



K155-DBN
BRIGHT NICKEL
BRUSHED DULL
1 1/8" DIA
15/16" PROJ



K155-SN
SATIN NICKEL
1 1/8" DIA
15/16" PROJ

| ITEM | MSRP |
|-------------|--------|
| K155-96ABSB | \$8.70 |
| K155-96DBAC | \$8.70 |
| K155-96DBN | \$8.70 |
| K155-96SN | \$8.70 |
| K155-ABSB | \$6.50 |
| K155-DBAC | \$6.50 |
| K155-DBN | \$6.50 |
| K155-SN | \$6.50 |



K155-96ABSB
ANTIQUE BRUSHED SATIN BRASS
4 1/4" L
96MM C/C



K155-96DBAC
DARK BRUSHED ANTIQUÉ COPPER
4 1/4" L 96MM C/C



K155-96DBN
BRIGHT NICKEL BRUSHED
DULL
4 1/4" L
96MM C/C



K155-96SN
SATIN NICKEL
4 1/4" L 96MM C/C

H-Select

BALANCE



K2980-AB
ANTIQUE ENGLISH
1 1/4" DIA
1 1/8" PROJ



K2980-DACM
DARK BRUSHED
COPPER MACHINED
1 1/4" DIA
1 1/8" PROJ



K2980-SN
SATIN NICKEL
1 1/4" DIA
1 1/8" PROJ



K2980-DBAC
DARK BRUSHED
ANTIQUÉ COPPER
1 1/4" DIA
1 1/8" PROJ



K2980-ORB
OIL-RUBBED
BRONZE
1 1/4" DIA
1 1/8" PROJ



K2981-AB
ANTIQUE ENGLISH
3 3/4" L
3" C/C



K2981-DACM
DARK BRUSHED COPPER MACHINED
3 3/4" L
3" C/C



K2981-DBAC
DARK BRUSHED ANTIQUÉ COPPER
3 3/4" L
3" C/C



K2981-SN
SATIN NICKEL
3 3/4" L
3" C/C



K2981-ORB
OIL-RUBBED BRONZE
3 3/4" L
3" C/C

| ITEM | MSRP |
|------------|--------|
| K2980-AB | \$4.90 |
| K2980-DACM | \$4.90 |
| K2980-DBAC | \$4.90 |
| K2980-ORB | \$4.90 |
| K2980-SN | \$4.90 |
| K2981-AB | \$5.54 |
| K2981-DACM | \$5.54 |
| K2981-DBAC | \$5.54 |
| K2981-ORB | \$5.54 |
| K2981-SN | \$5.54 |

H-SELECT

CLARK

ZINC DIE CAST



K801-B
PEWTER
1 1/8" DIA
1 1/8" PROJ



K800-SN
SATIN NICKEL
1 1/8" DIA
1 1/8" PROJ



K802-AE
ANTIQUE ENGLISH
1 1/8" DIA
1 1/8" PROJ



K803-BI
BLACK IRON
1 1/8" DIA
1 1/8" PROJ



K810-MB
MATTE BLACK
1 1/8" DIA
1 1/8" PROJ



K804-B
PEWTER
3 3/4" L
3" C/C



K805-SN
SATIN NICKEL
3 3/4" L
3" C/C



K806-AE
ANTIQUE ENGLISH
3 3/4" L
3" C/C



K807-BI
BLACK IRON
3 3/4" L
3" C/C



K811-MB
MATTE BLACK
3 3/4" L
3" C/C

| ITEM | MSRP |
|---------|--------|
| K800-SN | \$1.96 |
| K801-B | \$3.30 |
| K802-AE | \$3.30 |
| K803-BI | \$3.30 |
| K804-B | \$5.00 |
| K805-SN | \$5.00 |
| K806-AE | \$5.00 |
| K807-BI | \$5.00 |
| K810-MB | \$1.96 |
| K811-MB | \$5.00 |

BAR PULLS



K1001
BRUSHED NICKEL
1 9/16" L
1 3/8" PROJ



K1000
BRUSHED NICKEL
4 1/2" L
76MM C/C



K1002
BRUSHED NICKEL
5 5/16" L
96MM C/C



K1003
BRUSHED NICKEL
6 5/8" L
128MM C/C



K1004
BRUSHED NICKEL
7 7/8" L
160MM C/C



K1005
BRUSHED NICKEL
9 1/8" L
192MM C/C

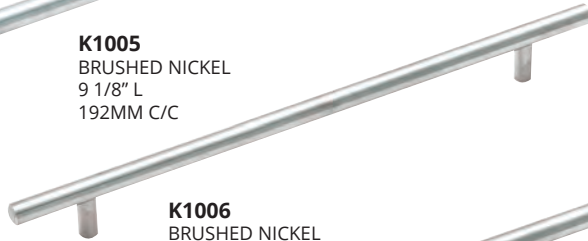

K1006
BRUSHED NICKEL
10 3/8" L
224MM C/C



K1007
BRUSHED NICKEL
11 5/8" L
256MM C/C



K1008
BRUSHED NICKEL
12 7/8" L
288MM C/C



K1009
BRUSHED NICKEL
14 3/16" L
320MM C/C



K1010
BRUSHED NICKEL
15 7/16" L
352MM C/C

| ITEM | MSRP |
|-------|---------|
| K1000 | \$5.90 |
| K1001 | \$2.50 |
| K1002 | \$6.20 |
| K1003 | \$6.60 |
| K1004 | \$7.00 |
| K1005 | \$7.50 |
| K1006 | \$7.90 |
| K1007 | \$8.30 |
| K1008 | \$9.50 |
| K1009 | \$9.90 |
| K1010 | \$10.50 |

H-Select

SLEEK & MODERN

H-SELECT



K1216-SN
SATIN NICKEL
7/8" DIA
1" PROJ



K426-SN
SATIN NICKEL
7/8" DIA
1" PROJ



K26-SN
SATIN NICKEL
1" DIA
15/16" PROJ



K8026-SN
SATIN NICKEL
1 3/4" L
3/4" PROJ



K515-SN
SATIN NICKEL
1 1/8" DIA
1" PROJ



D2753-SN
SATIN NICKEL
1 5/16" L
1 1/8" PROJ



K790-SN
SATIN NICKEL
1" DIA
1" PROJ



Z259-BL
BLACK
3 3/8" L
3" C/C



Z259-SN
SATIN NICKEL
3 3/8" L
3" C/C



K400-SN
SATIN NICKEL
4" L
3" C/C



K475-SN
SATIN NICKEL
4 3/4" L
96MM C/C



K3489-SN
SATIN NICKEL
4 1/2" L
3" C/C



K3489-MB
MATTE BLACK
4 1/2" L
3" C/C



K272-BL
BLACK
4 5/8" L
96MM C/C



K4690-SN
SATIN NICKEL
4 3/4" L
96MM C/C



K272-SN
SATIN NICKEL
4 5/8" L
96MM C/C



K2017-SN
SATIN NICKEL
5" L
96MM C/C



K961-DSN
SATIN NICKEL
4 3/4" L
3" CC



K2017-BL
BLACK
5" L
96MM C/C



K4655-SN
SATIN NICKEL
6 1/4" L
5" C/C



K4655-BLK
BLACK
6 1/4" L
5" C/C



K4655-AB
ANTIQUÉ ENGLISH
6 1/4" L
5" C/C



K5319-SN
SATIN NICKEL
14 1/8" L
12 1/2" C/C

| ITEM | MSRP |
|-----------|---------|
| D2753-SN | \$5.26 |
| K26-SN | \$4.90 |
| K272-BL | \$4.90 |
| K272-SN | \$4.90 |
| K400-SN | \$6.50 |
| K426-SN | \$3.70 |
| K475-SN | \$6.70 |
| K515-SN | \$3.70 |
| K790-SN | \$4.38 |
| K961-DSN | \$6.00 |
| K1216-SN | \$3.70 |
| K2017-BL | \$4.50 |
| K2017-SN | \$4.50 |
| K3489-MB | \$6.00 |
| K3489-SN | \$6.00 |
| K4655-AB | \$5.80 |
| K4655-BLK | \$5.80 |
| K4655-SN | \$5.80 |
| K4690-SN | \$5.70 |
| K5319-SN | \$13.50 |
| K8026-SN | \$3.70 |
| Z259-BL | \$4.50 |
| Z259-SN | \$4.50 |

H-Select

GLENDALE



K525-DBAC
DARK BRUSHED ANTIQUE
COPPER
1 1/16" SQ
1" PROJ



K525-DMAC
DARK MACHINED ANTIQUE
COPPER
1 1/16" SQ
1" PROJ

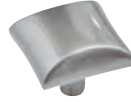

K525-SN
SATIN NICKEL
1 1/16" SQ
1" PROJ

| ITEM | MSRP |
|-------------|--------|
| K525-96DBAC | \$5.50 |
| K525-96DMAC | \$5.50 |
| K525-96SN | \$5.50 |
| K525-DBAC | \$3.90 |
| K525-DMAC | \$3.90 |
| K525-SN | \$3.90 |



K525-96DBAC
DARK BRUSHED
ANTIQUÉ COPPER
5" L
96MM C/C



K525-96DMAC
DARK MACHINED
ANTIQUÉ COPPER
5" L
96MM C/C



K525-96SN
SATIN NICKEL
5" L
96MM C/C

KINGSPORT



K150-LP
LANCASTER ANTIQUE
2 7/8" X 4 1/4"
3" C/C

| ITEM | MSRP |
|---------|--------|
| K150-LP | \$4.70 |

WHEAT



DRAWER BAIL PULL
K200-LP
LANCASTER ANTIQUE
2 5/8" X 4 1/2"
3" C/C



KNOB
K204-LP
LANCASTER ANTIQUE
1 1/4" DIA
1 1/4" PROJ



BAR HANDLE
K205-LP
LANCASTER ANTIQUE
4 1/4" L
3" C/C

| ITEM | MSRP |
|---------|--------|
| K200-LP | \$5.18 |
| K204-LP | \$5.18 |
| K205-LP | \$5.18 |

OLD ENGLISH



K152-AE
ANTIQUÉ ENGLISH
4 3/4" L
3" C/C



K706-AE
ANTIQUÉ ENGLISH
4 7/8" L
3" C/C



K707-AE
ANTIQUÉ ENGLISH
4 1/4" L
2 1/2" C/C

| ITEM | MSRP |
|---------|--------|
| K152-AE | \$5.40 |
| K706-AE | \$5.40 |
| K707-AE | \$5.40 |

H-SELECT

LAFAYETTE



K417-ABSB
ANTIQUE BRUSHED SATIN BRASS
1 3/8" DIA
1 1/4" PROJ



K417-DBAC
DARK BRUSHED ANTIQUE COPPER
1 3/8" DIA
1 1/4" PROJ



K417-DBN
BRIGHT NICKEL BRUSHED DULL
1 3/8" DIA
1 1/4" PROJ



K517-ABSB
ANTIQUE BRUSHED SATIN BRASS
1 3/8" DIA
1 1/4" PROJ



K517-DBAC
DARK BRUSHED ANTIQUE COPPER
1 3/8" DIA
1 1/4" PROJ



K517-DBN
BRIGHT NICKEL BRUSHED DULL
1 3/8" DIA
1 1/4" PROJ

| ITEM | MSRP |
|--------------------|---------|
| K317-96ABSB | \$10.70 |
| K317-96DBAC | \$10.70 |
| K317-96DBN | \$10.70 |
| K417-ABSB | \$8.92 |
| K417-DBAC | \$8.92 |
| K417-DBN | \$8.92 |
| K517-ABSB | \$6.50 |
| K517-DBAC | \$6.50 |
| K517-DBN | \$6.50 |



K317-96ABSB
ANTIQUE BRUSHED SATIN BRASS
4 3/8" L
96MM C/C



K317-96DBAC
DARK BRUSHED ANTIQUE COPPER
4 3/8" L
96MM C/C



K317-96DBN
BRIGHT NICKEL BRUSHED DULL
4 3/8" L
96MM C/C

RICHELIEU



Knob
K147-AE
ANDOVER ANTIQUE
1 3/8" L
1 1/8" PROJ



BACKPLATE
K105-AE
ANDOVER ANTIQUE
1" X 4 1/8"

| ITEM | MSRP |
|----------------|--------|
| K105-AE | \$5.90 |
| K147-AE | \$5.90 |

ANTIQUE ENGLISH



A76209-AE
ANTIQUE ENGLISH
1 1/8" DIA
1" PROJ



D89-AE
ANTIQUE ENGLISH
3/4" DIA
5/8" PROJ



D89-BL
BLACK
3/4" DIA
5/8" PROJ



K208-AE
ANTIQUE ENGLISH
1 1/8" DIA
3/4" PROJ

| ITEM | MSRP |
|------------------|--------|
| A76209-AE | \$3.50 |
| D89-AE | \$3.00 |
| D89-BL | \$3.00 |
| K156-AE | \$5.40 |
| K157-AE | \$5.50 |
| K208-AE | \$3.20 |
| K3208-AE | \$5.00 |
| K703-AE | \$3.70 |
| K763-AE | \$5.98 |



K157-AE
ANTIQUE ENGLISH
4 3/4" L
3" C/C



K703-AE
ANTIQUE ENGLISH
5 1/2" L



K763-AE
ANTIQUE ENGLISH
5 3/8" L
3" C/C



K3208-AE
ANTIQUE ENGLISH
4 1/4" L
3" C/C



K156-AE
ANTIQUE ENGLISH
4 1/2" L
3" C/C

H-Select

STICKLEY MISSION II

ZINC DIE CAST



D924-AC
ANTIQUE COPPER
3 3/4" X 1"
3" C/C



D924-AE
ANTIQUE ENGLISH
3 3/4" X 1"
3" C/C



D924-BL
BLACK
3 3/4" X 1"
3" C/C



D925-AC
ANTIQUE COPPER
1 5/8" X 3 1/2"
3" C/C



D925-AE
ANTIQUE ENGLISH
1 5/8" X 3 1/2"
3" C/C



D925-BL
BLACK
1 5/8" X 3 1/2"
3" C/C

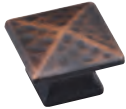

D942-AC
ANTIQUE COPPER
1 1/4" SQ
7/8" PROJ

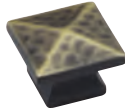

D942-AE
ANTIQUE ENGLISH
1 1/4" SQ
7/8" PROJ

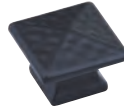

D942-BL
BLACK
1 1/4" SQ
7/8" PROJ

| ITEM | MSRP |
|---------|--------|
| D924-AC | \$7.10 |
| D924-AE | \$7.10 |
| D924-BL | \$7.10 |
| D925-AC | \$7.10 |
| D925-AE | \$7.10 |
| D925-BL | \$7.10 |
| D942-AC | \$5.90 |
| D942-AE | \$5.90 |
| D942-BL | \$5.90 |

H-SELECT

PERIOD MISSION



D552-AC
ANTIQUE COPPER
4 1/2" X 1 1/4"
3" C/C



D552-BL
BLACK
4 1/2" X 1 1/4"
3" C/C



D552-ORB
OIL-RUBBED BRONZE
4 1/2" X 1 1/4"
3" C/C

| ITEM | MSRP |
|----------|--------|
| D552-AC | \$7.30 |
| D552-BL | \$7.30 |
| D552-ORB | \$7.30 |
| D553-AC | \$7.30 |
| D553-BL | \$7.30 |
| D553-ORB | \$7.30 |



D553-AC
ANTIQUE COPPER
1 1/4" X 4 1/2"
3" C/C



D553-BL
BLACK
1 1/4" X 4 1/2"
3" C/C



D553-ORB
OIL-RUBBED BRONZE
1 1/4" X 4 1/2"
3" C/C

TRADITIONAL MISSION

HEAVY DUTY BAILS



D527-A
BLACK
3 3/4" X 1"
2 1/4" C/C



D527-AE
ANTIQUE ENGLISH
3 3/4" X 1"
2 1/4" C/C



D527-B
PEWTER
3 3/4" X 1"
2 1/4" C/C

| ITEM | MSRP |
|---------|--------|
| D527-A | \$4.10 |
| D527-AE | \$4.10 |
| D527-B | \$4.10 |
| D528-A | \$5.26 |
| D528-AE | \$5.26 |
| D528-B | \$5.26 |
| D529-A | \$5.26 |
| D529-AE | \$5.26 |
| D529-B | \$5.26 |



D528-A
BLACK
1 3/4" X 2 3/4"
1 1/8" C/C



D528-AE
ANTIQUE ENGLISH
1 3/4" X 2 3/4"
1 1/8" C/C



D528-B
PEWTER
1 3/4" X 2 3/4"
1 1/8" C/C



D529-A
BLACK
2" X 3 3/4"
3" C/C



D529-AE
ANTIQUE ENGLISH
2" X 3 3/4"
3" C/C



D529-B
PEWTER
2" X 3 3/4"
3" C/C

H-SELECT

REFINED MISSION



D523-BL
BLACK
1 1/8" DIA
1" PROJ



D523-SN
SATIN NICKEL
1 1/8" DIA
1" PROJ



D523-W
WROUGHT IRON
1 1/8" DIA
1" PROJ



D521-BL
BLACK
4 1/16" L
3" C/C



D521-SN
SATIN NICKEL
4 1/16" L
3" C/C



D521-W
WROUGHT IRON
4 1/16" L
3" C/C



HH4424-BL
BLACK
4" L
3" C/C



HH4425-BL
BLACK
1 1/4" DIA
1 1/8" PROJ

| ITEM | MSRP |
|-----------|--------|
| D521-BL | \$5.20 |
| D521-SN | \$5.20 |
| D521-W | \$5.20 |
| D523-BL | \$3.96 |
| D523-SN | \$3.96 |
| D523-W | \$3.96 |
| HH4424-BL | \$9.00 |
| HH4425-BL | \$6.00 |

STICKLEY MISSION I

SOLID BRASS
PYRAMID HEAD SCREW (INCLUDED)



D526
BRASS
3 3/4" X 1 1/4"



D526-BL
BLACK IRON
3 3/4" X 1 1/4"



D526-AE
ANTIQUE ENGLISH
3 3/4" X 1 1/4"



D525
BRASS
1 1/2" X 3 1/8"

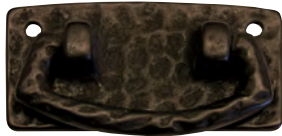

D525-BL
BLACK IRON
1 1/2" X 3 1/8"



D525-AE
ANTIQUE ENGLISH
1 1/2" X 3 1/8"

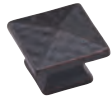

D542-AC
ANTIQUED COPPER
1 3/16" SQ
7/8" PROJ

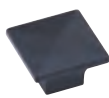

D522-BL
BLACK
1 1/4" SQ
7/8" PROJ



D524-BI
BLACK CAST IRON
1 1/8" SQ
7/8" PROJ

| ITEM | MSRP |
|---------|---------|
| D522-BL | \$6.20 |
| D524-BI | \$7.90 |
| D525 | \$17.00 |
| D525-AE | \$17.00 |
| D525-BL | \$17.00 |
| D526 | \$13.90 |
| D526-AE | \$13.90 |
| D526-BL | \$13.90 |
| D542-AC | \$10.70 |

HAMMERED MISSION



D550
ANTIQUED COPPER
1 3/4" X 3 1/2"
3" C/C



D550-A
BLACK
1 3/4" X 3 1/2"
3" C/C



D550-B
PEWTER
1 3/4" X 3 1/2"
3" C/C



D551
ANTIQUED COPPER
3 1/2" X 1 3/4"



D551-B
PEWTER
3 1/2" X 1 3/4"

| ITEM | MSRP |
|--------|--------|
| D550 | \$7.30 |
| D550-A | \$7.30 |
| D550-B | \$7.30 |
| D551 | \$7.30 |
| D551-B | \$7.30 |

ELEGANT ART



D560-AP
ANTIQUED PEWTER
1 1/4" X 3 3/4"
2 1/8" C/C



D561-AP
ANTIQUED PEWTER
3 3/4" X 1 1/4"

| ITEM | MSRP |
|---------|--------|
| D560-AP | \$9.30 |
| D561-AP | \$9.30 |

LIBERTY MISSION



K8005
BLACK IRON
1 1/2" X 4 7/8"
4 1/4" C/C



K8006
BLACK IRON
4 7/8" X 1 1/2"
4 1/4" C/C

| ITEM | MSRP |
|--------------|--------|
| K8005 | \$6.50 |
| K8006 | \$5.90 |

BIRDCAGE



K1350-DACM
DARK BRUSHED
COPPER MACHINED
2 1/4" L
1 3/8" PROJ



K1350-SIM
PEWTER
2 1/4" L
1 3/8" PROJ

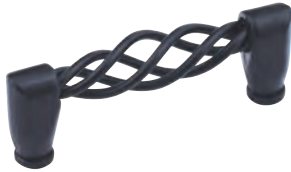

K1300-DACM
DARK BRUSHED
COPPER MACHINED
3 1/2" L
3" C/C



K1300-SIM
PEWTER
3 1/2" L
3" C/C

| ITEM | MSRP |
|-------------------|--------|
| K1300-DACM | \$6.20 |
| K1300-SIM | \$6.20 |
| K1350-DACM | \$3.50 |
| K1350-SIM | \$3.50 |

IRON FORGE



K58-BL
MATTE BLACK
1 1/2" L
1 1/4" PROJ



K558-BL
MATTE BLACK
6" L
96MM C/C



K58-SI
SWEDISH IRON
1 1/2" L
1 1/4" PROJ



K558-SI
SWEDISH IRON
6" L
96MM C/C



K469-BL
MATTE BLACK
" L
MM C/C



K469-SIM
PEWTER
" L
MM C/C



K462-BL
MATTE BLACK
4 5/8" L
96MM C/C



K462-SIM
PEWTER
4 5/8" L
96MM C/C

| ITEM | MSRP |
|-----------------|--------|
| K58-BL | \$4.60 |
| K58-SI | \$4.60 |
| K462-BL | \$9.90 |
| K462-SIM | \$9.90 |
| K558-BL | \$7.98 |
| K558-SI | \$7.98 |
| K469-BL | \$4.50 |
| K469-SIM | \$4.50 |

OLD WORLD



K530-W
WINDOVER ANTIQUE
1 3/4" X 1 1/4"
1 1/4" PROJ



K089-W
WROUGHT IRON
4 3/4" L
3 5/8" C/C



K570-W
WROUGHT IRON
1" DIA
3/4" PROJ



K3248-W
WROUGHT IRON
1" DIA
7/8" PROJ



K1814-W
WROUGHT IRON
3/4" DIA
3/4" PROJ



K3222-W
WROUGHT IRON
1 7/8" X 1 7/16"
5/8" PROJ

| ITEM | MSRP |
|----------------|--------|
| K089-W | \$5.58 |
| K530-W | \$5.00 |
| K570-W | \$4.50 |
| K1814-W | \$3.90 |
| K3222-W | \$4.50 |
| K3248-W | \$3.90 |

RUSTIC



K3272-DACM
DARK BRUSHED
COPPER MACHINED
1 3/16" L
1 1/4" PROJ



K3031-DACM
DARK BRUSHED COPPER MACHINED
2" DIA
1 1/8" PROJ



K3273-DACM
DARK BRUSHED
COPPER MACHINED
4 1/2" L
96MM C/C



K4240-96-BL
BLACK
4 1/2" L
96MM C/C



K4240-128-BL
BLACK
5 3/4" L
128MM C/C



K8900-5-BL
BLACK
6 1/4" L
5" C/C



K8900-12-BL
BLACK
13" L
11 15/16" C/C

| ITEM | MSRP |
|---------------------|---------|
| K3031-DACM | \$5.28 |
| K3272-DACM | \$5.00 |
| K3273-DACM | \$7.90 |
| K4240-96-BL | \$8.50 |
| K4240-128-BL | \$9.00 |
| K8900-5-BL | \$11.00 |
| K8900-12-BL | \$35.70 |

H-SELECT

TRANQUIL



K5302-AB
ANTIQU BRASS/ WHITE
1 1/4" DIA
1" PROJ



K5302-AB-O
ANTIQU BRASS/ OAK
1 1/4" DIA
1" PROJ



K5302-PB
POLISHED BRASS/ WHITE
1 1/4" DIA
1" PROJ



K5302-PB-O
POLISHED BRASS/ OAK
1 1/4" DIA
1" PROJ



P226
OATMEAL
1 1/4" DIA
7/8" PROJ



P220
WHITE
1" DIA
1" PROJ



P225
WHITE
1 1/4" DIA
7/8" PROJ

| ITEM | MSRP |
|-------------------|--------|
| K5302-AB | \$4.50 |
| K5302-AB-O | \$4.50 |
| K5302-PB | \$4.50 |
| K5302-PB-O | \$4.50 |
| K5312-AB | \$5.98 |
| K5312-AB-O | \$5.98 |
| K5312-PB | \$5.98 |
| K5312-PB-O | \$5.98 |
| P220 | \$4.50 |
| P225 | \$3.00 |
| P226 | \$3.00 |



K5312-AB
ANTIQU BRASS/ WHITE
5" L
3" C/C



K5312-AB-O
ANTIQU BRASS/ OAK
5" L
3" C/C



K5312-PB
POLISHED BRASS/ WHITE
5" L
3" C/C



K5312-PB-O
POLISHED BRASS/ OAK
5" L
3" C/C

H-Select

PALISADE



K3211-PB
BRASS PLATED
4 7/8" L
3" C/C



K3211-SN
SATIN NICKEL
4 7/8" L
3" C/C



K2910-SN
SATIN NICKEL
4 7/8" L
3" C/C

| ITEM | MSRP |
|----------|--------|
| K3211-PB | \$5.98 |
| K3211-SN | \$5.98 |
| K2910-SN | \$5.98 |

H-SELECT

WILLOW



K329-LP
LANCASTER ANTIQUE
3" X 4"
3" C/C



K8018-LP
LANCASTER ANTIQUE
1 7/8" X 1 1/2"



K321-LP
LANCASTER ANTIQUE
1 1/8" L
1" PROJ



BACKPLATE
K326-LP
LANCASTER ANTIQUE
1" X 5 1/2"

| ITEM | MSRP |
|----------|---------|
| K321-LP | \$5.84 |
| K326-LP | \$8.64 |
| K329-LP | \$14.48 |
| K8018-LP | \$5.48 |

SOLID BRASS



K6641-SN
SATIN NICKEL
3/4" DIA
3/4" PROJ



K6640
POLISHED BRASS
5/8" DIA
5/8" PROJ



K6641
POLISHED BRASS
3/4" DIA
3/4" PROJ



K6641-A
BLACK
3/4" DIA
3/4" PROJ

| ITEM | MSRP |
|----------|---------|
| K15 | \$9.98 |
| K1884 | \$5.98 |
| K1908 | \$11.90 |
| K38 | \$7.30 |
| K39 | \$11.90 |
| K6640 | \$5.00 |
| K6641 | \$5.00 |
| K6641-A | \$5.00 |
| K6641-SN | \$5.00 |



MOCK KEY
K1884
POLISHED BRASS
1 1/8" L
1" PROJ



K1908
POLISHED BRASS
4" X 4"
3" C/C



K15
POLISHED BRASS
4" L
3" C/C



K38
POLISHED BRASS
3/4" X 5 1/4"



BACKPLATE
K39
POLISHED BRASS
7/8" X 6 3/4"

MOCK KEY
K1884
POLISHED BRASS
1 1/8" L
1" PROJ

SHAKER KNOBS

- COMES WITH INSERTS
- END GRAIN



KR15-OAK
OAK
KR15-C
CHERRY
KR15-M
MAPLE
KR15-W
WALNUT
1 1/16" DIA
1 1/16" PROJ



KR15-BL
BLACK PAINT
1 1/16" DIA
1 1/16" PROJ



KR16-OAK
OAK
KR16-C
CHERRY
7/8" DIA
15/16" PROJ



KR16-BL
BLACK PAINT
7/8" DIA
15/16" PROJ

| ITEM | MSRP |
|-----------------|--------|
| KR15-OAK | \$1.86 |
| KR15-BL | \$1.86 |
| KR15-C | \$1.86 |
| KR15-M | \$1.86 |
| KR15-W | \$1.86 |
| KR16-OAK | \$1.80 |
| KR16-C | \$1.80 |
| KR16-BL | \$1.80 |

ORDER SCREWS SEPARATELY

MISSION

- COMES WITH INSERTS
- USE 8/32 BOLTS



K49-D
OAK
1 3/4" SQ

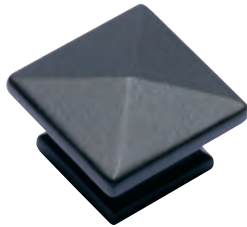

K49-B
OAK
1 1/4" SQ
K49-BC
CHERRY
1 1/4" SQ
K52-B
WALNUT
1 1/4" SQ
K53-BL
BLACK
1 1/4" SQ

| ITEM | MSRP |
|---------------|--------|
| K49-B | \$2.32 |
| K49-BC | \$2.32 |
| K49-D | \$2.44 |
| K52-B | \$2.32 |
| K53-BL | \$2.12 |

ORDER SCREWS SEPARATELY

PREMIUM MISSION

- COMES WITH INSERTS
- USE 8/32 BOLTS



K50-B
OAK
1 1/4" SQ
K51-B
CHERRY
1 1/4" SQ
K54-B
MAPLE
1 1/4" SQ



K50-C
OAK
1 1/2" SQ
K51-C
CHERRY
1 1/2" SQ
K54-C
MAPLE
1 1/2" SQ



K49-H
OAK
3" C/C

| ITEM | MSRP |
|--------------|--------|
| K49-H | \$5.00 |
| K50-B | \$2.92 |
| K50-C | \$3.20 |
| K51-B | \$3.34 |
| K51-C | \$3.40 |
| K54-B | \$3.12 |
| K54-C | \$3.30 |

DIAMOND MISSION

- USE WITH MISSION OR ANY OTHER CUSTOM DESIGNS
- COMES WITH INSERTS



DIAMOND SHAPED WOOD KNOB WITH DIAMOND FACE

K70
WALNUT
1 1/2" X 2"
K70-A
OAK
1 1/2" X 2"

| ITEM | MSRP |
|--------------|--------|
| K70 | \$3.80 |
| K70-A | \$2.50 |

WOOD KNOBS I

- COMES WITH INSERTS
- FACE GRAIN
- USE 8/32 BOLTS



K40-A
OAK
1" DIA

K45-A
CHERRY
1" DIA

K47-A
OAK
1" DIA

K41-A
BEECH
1" DIA

K46-A
WALNUT
1" DIA



K40-B
OAK
1 1/4" DIA

K47-B
OAK
1 1/4" SQ

K40-C
OAK
1 1/2" DIA

K47-C
OAK
1 1/2" SQ

K41-B
BEECH
1 1/4" DIA

K48-B
CHERRY
1 1/4" SQ

K41-C
BEECH
1 1/2" DIA

K44-B
HICKORY
1 1/4" DIA

K45-C
CHERRY
1 1/2" DIA

K45-B
CHERRY
1 1/4" DIA

K46-C
WALNUT
1 1/2" DIA

K46-B
WALNUT
1 1/4" DIA

K55-C
MAPLE
1 1/2" DIA

K55-B
MAPLE
1 1/4" DIA

K56-C
QTR. SAWN W. OAK
1 1/2" DIA

K56-B
QTR. SAWN W. OAK
1 1/4" DIA

K57-B
GRAY ELM
1 1/4" DIA

| ITEM | MSRP |
|-------|--------|
| K40-A | \$1.30 |
| K40-B | \$1.48 |
| K40-C | \$1.56 |
| K41-A | \$1.22 |
| K41-B | \$1.36 |
| K41-C | \$1.30 |
| K44-B | \$2.60 |
| K45-A | \$1.40 |
| K45-B | \$1.88 |
| K45-C | \$1.92 |
| K46-A | \$1.50 |
| K46-B | \$2.10 |
| K46-C | \$1.90 |
| K47-A | \$1.20 |
| K47-B | \$1.30 |
| K47-C | \$1.50 |
| K48-B | \$1.80 |
| K55-B | \$1.90 |
| K55-C | \$1.92 |
| K56-B | \$2.10 |
| K56-C | \$2.18 |
| K57-B | \$2.10 |

ORDER SCREWS SEPARATELY

H-SELECT

WOOD KNOBS II

- COMES WITH INSERTS
- FACE GRAIN



OVAL SHAPED WOOD KNOB

K114-M
MAPLE
1 7/8" X 1 1/2"
1 1/16" PROJ

K114-W
OAK
1 7/8" X 1 1/2"
1 1/16" PROJ

| ITEM | MSRP |
|--------|--------|
| K114-O | \$7.88 |
| K114-M | \$7.56 |

ORDER SCREWS SEPARATELY

WOOD KNOBS IV



K4275
OAK
1 3/8" DIA

K4375
WALNUT
1 3/8" DIA



K4277
OAK
1 3/4" DIA

K4377
WALNUT
1 3/4" DIA



K4278
OAK
2" DIA

K4378
WALNUT
2" DIA

| ITEM | MSRP |
|-------|--------|
| K4275 | \$2.40 |
| K4277 | \$3.44 |
| K4278 | \$3.88 |
| K4375 | \$2.76 |
| K4377 | \$4.10 |
| K4378 | \$4.72 |

ORDER SCREWS SEPARATELY

WOOD HANDLES



BBW1
OAK
5 1/2" C/C, 7" W X 1 3/8" H



BBW8
OAK
3 3/4" C/C, 4 1/2" W X 7/8" H



BBW2
OAK
3 1/2" C/C, 5" W X 1 3/8" H



BBW9
OAK
3 3/4" C/C, 4 1/4" W X 1 3/4" H
BBW9-A
CHERRY
3 3/4" C/C, 4 1/4" W X 1 3/4" H



BBW4
OAK
5 1/2" C/C, 7" W X 1 3/8" H



BBW12
OAK
3" C/C, 5 1/2" W



BBW5
OAK
3 3/4" C/C, 5" W X 1 3/8" H



BBW15
OAK
5" C/C, 7 1/4" W

BBW5-A
CHERRY
3 3/4" C/C, 5" W X 1 3/8" H

| ITEM | MSRP |
|---------------|---------|
| BBW1 | \$11.76 |
| BBW2 | \$7.86 |
| BBW2-A | \$7.86 |
| BBW4 | \$7.00 |
| BBW5 | \$7.00 |
| BBW5-A | \$8.00 |
| BBW8 | \$5.00 |
| BBW9 | \$6.26 |
| BBW9-A | \$6.26 |
| BBW12 | \$12.58 |
| BBW15 | \$7.04 |

ORDER SCREWS SEPARATELY

H-SELECT

HOOKS



Q15 SOLID BRASS 5" H
BASE 2" X 1 1/8"
Q15-F BLACK 5" H
BASE 2" X 1 1/8"
Q30 ANTIQUE BRASS 5" H
BASE 2 3/8" X 7/16"
Q34 BLACK 5 1/2" H
BASE 2" X 1 1/16"
Q4 SOLID BRASS 4 1/2" H
BASE 1 3/8" X 1 1/4"
Q4-F BLACK 4 1/2" H
BASE 1 3/8" X 1 1/4"

| ITEM | MSRP |
|--------------|---------|
| Q15 | \$19.38 |
| Q15-F | \$8.94 |
| Q30 | \$5.00 |
| Q34 | \$9.46 |
| Q4 | \$17.56 |
| Q4-F | \$9.20 |

ARTS AND CRAFTS

OLD CLASSIC

| ITEM | MSRP |
|--------|---------|
| Q351 | \$19.40 |
| Q351-A | \$20.54 |
| Q351-B | \$20.16 |

| ITEM | MSRP |
|--------|--------|
| Q31 | \$7.00 |
| Q32-BL | \$7.00 |
| Q33 | \$7.00 |



Q351
SOLID BRASS
5 1/2" H
BASE 2 1/4" X 9/16"



Q351-A
OIL-RUBBED BRONZE
5 1/2" H
BASE 2 1/4" X 9/16"



Q351-B
SATIN NICKEL
5 1/2" H
BASE 2 1/4" X 9/16"



Q31
ANTIQUE BRASS
5 1/2" H
BASE 1 1/2" X 1 3/4"



Q32-BL
FLAT BLACK
5 1/2" H
BASE 1 1/2" X 1 3/4"



Q33
BRASS
5 1/2" H
BASE 1 1/2" X 1 3/4"

RETRO



Q29
BRASS
5 1/2" H
BASE 1 3/4" X 1"



Q29-AE
ANTIQUENGLISH
5 1/2" H
BASE 1 3/4" X 1"



Q29-BL
BLACK
5 1/2" H
BASE 1 3/4" X 1"



Q29-ORB
OIL-RUBBED
BRONZE
5 1/2" H
BASE 1 3/4" X 1"



Q29-SN
SATIN NICKEL
5 1/2" H
BASE 1 3/4" X 1"

| ITEM | MSRP |
|---------|--------|
| Q29 | \$6.00 |
| Q29-AE | \$6.00 |
| Q29-BL | \$6.00 |
| Q29-ORB | \$6.00 |
| Q29-SN | \$6.00 |

JEWELRY HOOKS



KB3
ANTIQUE BRASS
1 1/2" H
BASE 1 1/4" X 5/8"



KB3-SN
SATIN NICKEL
1 1/2" H
BASE 1 1/4" X 5/8"



KB3-BL
BLACK
1 1/2" H
BASE 1 1/4" X 5/8"



Q96-BL
BLACK
1 1/2" H
BASE 1 3/8" X 3/4"



Q96-ORB
OIL-RUBBED
BRONZE
1 1/2" H
BASE 1 3/8" X 3/4"



Q96-SN
SATIN NICKEL
1 1/2" H
BASE 1 3/8" X 3/4"

| ITEM | MSRP |
|---------|--------|
| KB3 | \$2.50 |
| KB3-SN | \$2.50 |
| KB3-BL | \$2.50 |
| Q96-BL | \$2.50 |
| Q96-ORB | \$2.50 |
| Q96-SN | \$2.50 |

COUNTRY LATCHES



D1618-AB
ANTIQUE BRASS
LATCH ~ 2 1/8" X 1 1/2"
CATCH ~ 2 1/8" X 5/8"



D1618-PB
POLISHED BRASS
LATCH ~ 2 1/8" X 1 1/2"
CATCH ~ 2 1/8" X 5/8"



D1618-AC
ANTIQUE COPPER
LATCH ~ 2 1/8" X 1 1/2"
CATCH ~ 2 1/8" X 5/8"



D1618-PN
NICKEL
LATCH ~ 2 1/8" X 1 1/2"
CATCH ~ 2 1/8" X 5/8"



D1618-ORB
OIL-RUBBED BRONZE
LATCH ~ 2 1/8" X 1 1/2"
CATCH ~ 2 1/8" X 5/8"

| ITEM | MSRP |
|-----------|---------|
| D1618-AB | \$10.40 |
| D1618-PB | \$10.40 |
| D1618-AC | \$10.40 |
| D1618-PN | \$10.40 |
| D1618-ORB | \$10.40 |

DESK CARD HOLDERS



F1401
STAMPED BRASS
1 1/4" X 2 3/8"



F1403
STAMPED BRASS
1 1/2" X 3 1/8"



FF6
POLISHED BRASS
1" X 2 1/4"
11/16" PROJ
■ SOLID BRASS



FF6-BL
BLACK
1" X 2 1/4"
11/16" PROJ
■ SOLID BRASS



FF6-SN
SATIN NICKEL
1" X 2 1/4"
11/16" PROJ
■ SOLID BRASS

| ITEM | MSRP |
|--------|--------|
| F1401 | \$5.64 |
| F1403 | \$6.80 |
| FF6 | \$4.90 |
| FF6-BL | \$6.20 |
| FF6-SN | \$6.10 |

GROMMETS



BG1-PB
POLISHED BRASS
2 1/2" HOLE
3" DIA



BG2-PBL
PLASTIC BLACK
2 1/2" HOLE
3" DIA



BG3-PB
POLISHED BRASS
1 9/16" HOLE
2" DIA



BG4-SN
BRUSHED NICKEL
2 1/2" HOLE
3" DIA



BG5-BL
BLACK
1 9/16" HOLE
2" DIA



BG6-SN
BRUSHED NICKEL
1 9/16" HOLE
2" DIA



BG7-O
OAK
2 1/2" HOLE
3" DIA



BG8-M
MAPLE
2 1/2" HOLE
3" DIA



BG9-BL
BLACK
2 1/2" HOLE
3" DIA

| ITEM | MSRP |
|---------|---------|
| BG1-PB | \$6.74 |
| BG2-PBL | \$5.00 |
| BG3-PB | \$5.22 |
| BG4-SN | \$10.20 |
| BG5-BL | \$5.50 |
| BG6-SN | \$5.28 |
| BG7-O | \$7.06 |
| BG8-M | \$7.06 |
| BG9-BL | \$7.32 |

KEY HOLES



E1-AE
STAMPED BRASS
1" DIA



E1-PB
STAMPED BRASS
1" DIA



E3-AE
STAMPED BRASS
1 1/8" X 1 1/2"



E3-PB
STAMPED BRASS
1 1/8" X 1 1/2"

| ITEM | MSRP |
|-------|--------|
| E1-AE | \$2.88 |
| E1-PB | \$2.88 |
| E3-AE | \$2.88 |
| E3-PB | \$2.88 |

CHEVEL MIRROR MOUNTS I

SOLID BRASS CHEVEL MIRROR MOUNT

- INCLUDES 3 1/2" BOLTS W/ FRICTION WASHERS AND NUT

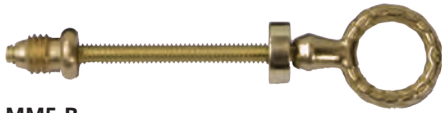

MM5-B
POLISHED BRASS

| ITEM | 1 PR |
|-------|---------|
| MM5-B | \$16.18 |

CHEVEL MIRROR MOUNTS II

ZINC DIE CAST CHEVEL MIRRORS MOUNTS

- 2 1/2" BOLTS COMES W/ FRICTION WASHERS AND NUT



M6-AB
ANTIQUÉ BRASS



M6-BL
BLACK



M6-SN
SATIN NICKEL

| ITEM | 1 PR |
|-------|---------|
| M6-AB | \$10.22 |
| M6-BL | \$9.94 |
| M6-SN | \$9.94 |

DECORATIVE HINGES - NON SELF-CLOSING

- FULL WRAP AROUND HINGE - FULL INSET
- FOR 3/4" FRAME & 3/4" DOOR, 270° OPENING
- STYLISH TIPS FOR SHAKER STYLE CABINETS WITH RAISED PANEL DOORS
- NON-MORTISE HINGE QUICKLY INSTALLS & YIELDS MINIMAL DOOR GAP
- #6 X 5/8" FLAT HEAD SCREW RECOMMENDED FOR ATTACHMENT TO FRAME AND #6 X 1/2" FLAT HEAD SCREW RECOMMENDED FOR DOOR ATTACHMENT
- SLOTTED HOLES PROVIDE HORIZONTAL & VERTICAL ADJUSTMENT



MINARET TIP FULL WRAP AROUND HINGE - FULL INSET

- V0138-DBAC**
DARK BRUSHED ANTIQUE COPPER
- V0138-MB**
MATTE BLACK
- V0138-SN**
SATIN NICKEL
- V0138-AB**
ANTIQUÉ BRASS
- V0138-WI**
WROUGHT IRON

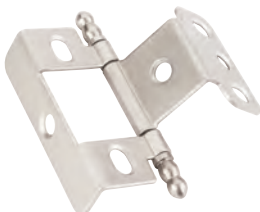

BALL TIP FULL WRAP AROUND HINGE - FULL INSET

- V0128-AB**
ANTIQUÉ BRASS
- V0128-DBAC**
DARK BRUSHED ANTIQUÉ COPPER
- V0128-MB**
MATTE BLACK
- V0128-SN**
SATIN NICKEL
- V0128-WI**
WROUGHT IRON



MINARET TIP PARTIAL WRAP AROUND HINGE - FULL INSET

- V0148-AB**
ANTIQUÉ BRASS
- V0148-DBAC**
DARK BRUSHED ANTIQUÉ COPPER
- V0148-MB**
MATTE BLACK
- V0148-SN**
SATIN NICKEL
- V0148-WI**
WROUGHT IRON

| ITEM | MSRP |
|------------|--------|
| V0128-AB | \$4.90 |
| V0128-DBAC | \$4.90 |
| V0128-MB | \$4.90 |
| V0128-SN | \$4.90 |
| V0138-AB | \$4.90 |
| V0138-DBAC | \$4.90 |
| V0138-MB | \$4.90 |
| V0138-SN | \$4.90 |
| V0148-AB | \$4.90 |
| V0148-DBAC | \$4.90 |
| V0148-MB | \$4.90 |
| V0148-SN | \$4.90 |
| V0128-WI | \$4.90 |
| V0138-WI | \$4.90 |
| V0148-WI | \$4.90 |

BIFOLD LOCKING HINGES



VBF10
2 1/2" H X 2 1/4" W
 ■ LOCKS OPEN OR CLOSED DOORS
 ■ HEAVY DUTY CONSTRUCTION

| ITEM | MSRP |
|-------|--------|
| VBF10 | \$6.30 |

H HINGES



V15-BL
BLACK
1 1/2" X 3 1/2"
 ■ INCLUDES SCREWS



V16-AB
ANTIQUE BRASS
1 1/2" X 3 1/2"



V19-AE
ANTIQUE ENGLISH
1 1/2" X 3 1/2"

| ITEM | MSRP |
|---------|--------|
| V149-AE | \$3.98 |
| V15-BL | \$2.08 |
| V16-AB | \$2.30 |
| V19-AE | \$2.70 |
| V25-AE | \$2.70 |
| V25-BL | \$2.50 |

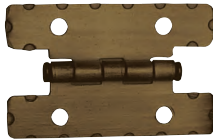

V25-AE
ANTIQUE ENGLISH
2 1/2" H



V25-BL
BLACK
2 1/2" H



V149-AE
ANTIQUE ENGLISH
1 1/2" X 1 1/2"
 ■ FINIAL TIP

HINGE I

SELF CLOSING SPRING



V11-AB
ANTIQUE BRASS
3/8" INSET



V30-AE
ANTIQUE ENGLISH
3/8" INSET



V73-BL
BLACK
3/8" INSET

| ITEM | SOLD IN | 1 PR |
|--------|---------|--------|
| V11-AB | PAIRS | \$4.70 |
| V30-AE | PAIRS | \$5.90 |
| V73-BL | PAIRS | \$5.90 |

HINGE III

SELF CLOSING SPRING



V10
POLISHED BRASS
FLUSH



V32-AE
ANTIQUE ENGLISH
FLUSH



V73-A
BLACK
FLUSH

| ITEM | SOLD IN | 1 PR |
|--------|---------|--------|
| V10 | PAIRS | \$5.90 |
| V32-AE | PAIRS | \$5.90 |
| V73-A | PAIRS | \$5.90 |

HINGE IV



V148-BL
BLACK



V148-SN
SATIN NICKEL



V148-WI
WROUGHT IRON

| ITEM | MSRP |
|---------|---------|
| V148-BL | \$10.00 |
| V148-SN | \$10.00 |
| V148-WI | \$10.00 |

SELF-CLOSING HINGES



V21-AB
ANTIQUE BRASS

- SEMI-CONCEALED
- 3/8" INSET WRAP AROUND



V22-AB
ANTIQUE BRASS
1/2" OVERLAY
■ WRAP AROUND HINGES
■ ADJUSTABLE MOUNTING HOLES

| ITEM | SOLD IN | 1 PR |
|--------|---------|--------|
| V21-AB | PAIRS | \$9.50 |
| V22-AB | PAIRS | \$9.50 |

YOUNGDALE KNIFE HINGES



V120
ANTIQUE BRASS
#4 = 3/8" INSET



V120-BL
BLACK
#4 = 3/8" INSET



V120-RB
OIL RUBBED BRONZE
#4 = 3/8" INSET



V120-NI
NICKEL
#4 = 3/8" INSET

| ITEM | SOLD IN | 1 PR |
|---------|---------|---------|
| V120 | PAIRS | \$7.96 |
| V120-RB | PAIRS | \$7.96 |
| V120-BL | PAIRS | \$10.30 |
| V120-NI | PAIRS | \$8.12 |
| V120-W | PAIRS | \$10.30 |
| V123 | PAIRS | \$7.96 |
| V125 | PAIRS | \$7.96 |
| V126 | PAIRS | \$7.96 |



V120-W
WHITE
#4 = 3/8" INSET



V123
ANTIQUE BRASS
#3 = 1/4" OVERLAY



V125
ANTIQUE BRASS
#5 = 5/16" OVERLAY



V126
ANTIQUE BRASS
#6 = 1/2" OVERLAY

FLUSH HINGE

- THREE-WAY ADJUSTABLE
- 90° ANGLE OF OPENING
- 35MM DIAMETER DRILL BIT NEEDED FOR INSTALLATION
- 12MM CUP DEPTH
- SCREWS INCLUDED
- SCREW ON WITH CHIP BOARD SCREWS 3 X 13MM



V170-AB
ANTIQUE BRASS

| ITEM | MSRP |
|---------|---------|
| V170-AB | \$13.42 |

SEWING MACHINE HINGES



V50-DAB
DARK ANTIQUE BRONZE
1 1/4" W X 3 1/8" L



V116-PB
POLISHED BRASS
1 3/16" W X 2 13/16" L



V116-AE
ANTIQUENGLISH
1 3/16" W X 2 13/16" L



V100-BZ
BRONZE
1 3/16" W X 2 9/16" L

| ITEM | MSRP |
|---------|---------|
| V50-DAB | \$2.50 |
| V116-PB | \$6.70 |
| V116-AE | \$6.70 |
| V100-BZ | \$14.48 |

BUTLER TRAY HINGES

- LEAF SPRING LOCKS HINGE AT 90° AND 180°
- SCREWS INCLUDED
- SIZE FULLY OPENED: 1 1/2" HIGH X 2 7/8" WIDE



V2010
HEAVY EXTRUDED BRASS



V2010-BL
BLACK

| ITEM | SOLD IN | 1 PR |
|----------|---------|---------|
| V2010 | PAIRS | \$23.90 |
| V2010-BL | PAIRS | \$23.90 |

NO MORTISE HINGES



BH16-A
ANTIQUENGLISH
2" H
BH16-BL
BLACK
2" H



V20-DAB
DARK ANTIQUE BRONZE
LID HINGE FOR 3/4" WOOD



BH14-DAB
2" H LARGE LEAF 7/8" W
BH14-BL
2" H LARGE LEAF 7/8" W
BH15-DAB
2 1/2" H LARGE LEAF 1" W
BH15A-DAB
3" H LARGE LEAF 1 1/16" W
■ FINIAL TIP

| ITEM | MSRP |
|-----------|--------|
| BH14-DAB | \$2.60 |
| BH14-BL | \$2.60 |
| BH15-DAB | \$2.60 |
| BH15A-DAB | \$3.90 |
| BH16-A | \$2.20 |
| BH16-BL | \$2.38 |
| V20-DAB | \$4.30 |

OVERLAY DOOR HINGE



V76-BL
BLACK

- HINGE FOR 270°
- WILL ALLOW CABINET DOORS TO FOLD AT SIDES

| ITEM | MSRP |
|--------|--------|
| V76-BL | \$5.00 |

BUTTERFLY HINGE



H110
BRASS PLATED STEEL
2" H X 2 1/4" L

| ITEM | MSRP |
|------|--------|
| H110 | \$2.70 |

PIE SAFE TINS

HERSHBERGER'S HARDWARE IS A DISTRIBUTOR FOR IRVIN'S TINS!

- HIGHEST QUALITY PIE SAFE TINS ON THE MARKET
- LACQUERED FINISH, NO PEEL OFF PLASTIC
- FRESH NEW DESIGNS
- SIZE 10" X 14"

| ITEM | MSRP |
|----------|---------|
| PST24-C | \$28.00 |
| PST24-BT | \$16.50 |
| PST25-C | \$28.00 |
| PST25-BT | \$16.50 |
| PST26-AT | \$16.50 |
| PST26-BT | \$16.50 |
| PST26-C | \$28.00 |
| PST27-AT | \$16.50 |
| PST27-C | \$28.00 |

H-SELECT



FEDERAL STAR
PST26-AT
ANTIQUÉ TIN



FEDERAL STAR
PST26-C
ANTIQUÉ COPPER



FEDERAL STAR
PST26-BT
BLACKENED TIN



3 STAR EMBOSSED
PST27-AT
ANTIQUÉ TIN



3 STAR EMBOSSED
PST27-C
ANTIQUÉ COPPER



WHEAT
PST24-BT
BLACKENED TIN



WHEAT
PST24-C
ANTIQUÉ COPPER



WHEAT
PST25-BT
BLACKENED TIN



WHEAT
PST25-C
ANTIQUÉ COPPER

SELF-ADHESIVE FELT

- GREAT FOR LINING GUN CABINETS, JEWELRY BOXES, ETC. FELT IS EASY-TO-USE
- JUST CUT TO SIZE, PEEL OFF BACK AND STICK IN PLACE!
- AVAILABLE IN FOUR GREAT COLORS
- SOLD BY THE RUNNING FOOT (54" ROLL WIDTH)

| ITEM | SOLD BY | MSRP |
|--------|---------|---------|
| AFBL-4 | FOOT | \$17.50 |
| AFGR-1 | FOOT | \$19.00 |
| AFRD-3 | FOOT | \$19.00 |



AFBL-4
BLACK
AFGR-1
GREEN
AFRD-3
RED

CUSTOM ORDERS

- WE WILL ALSO FILL YOUR CUSTOM ORDERS
- GIVE US YOUR SIZE AND WE'LL CUT TO FIT!
(SQUARE OR ROUNDS ONLY - 100 PIECE MINIMUM)



AMERICAN DINER

AVAILABLE FINISHES

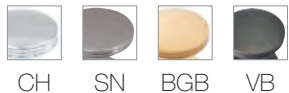

P2140-SN
Small Knob
1" Dia.



P2142-SN
Large Knob
1 3/8" Dia.

| ITEM | MSRP |
|--------------|---------|
| P2140 | \$8.78 |
| P2141 | \$15.88 |
| P2142 | \$11.68 |
| P2143 | \$12.08 |
| P2144 | \$15.20 |

NOTE: P2144 is not available in VB Finish.



P2143-SN
3" C/C



P2141-SN
96MM C/C



P2144-SN
3" & 96MM C/C

BRIDGES

AVAILABLE FINISHES

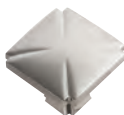

P3230-SN
1 5/32" SQ
1" PROJ

| ITEM | MSRP |
|--------------|---------|
| P3230 | \$11.06 |
| P3231 | \$11.68 |
| P3232 | \$14.86 |



P3231-SN
3" C/C, 3 5/8" L



P3232-SN
96MM C/C, 4 7/16" L

BUNGALOW

AVAILABLE FINISHES



P2153-OBH
3" & 96MM C/C

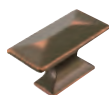

P2150-OBH
Small Knob
1 1/4" L

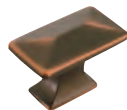

P2151-OBH
Medium Knob
1 3/4" L

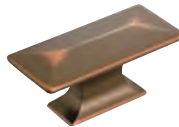

P2152-OBH
Large Knob
2 5/16" L

| ITEM | MSRP |
|--------------|---------|
| P2150 | \$8.12 |
| P2151 | \$12.58 |
| P2152 | \$12.84 |
| P2153 | \$15.24 |

CHARLESTON BLACKSMITH

AVAILABLE FINISHES



P1311-RI
Knob
1 1/2" Dia.



P1312-RI
Knob
1 1/4" Dia.

| ITEM | MSRP |
|---------------|---------|
| PA1322 | \$13.60 |
| PA1323 | \$12.08 |
| PA1311 | \$8.38 |
| PA1312 | \$9.64 |
| PA1321 | \$11.06 |



P1321-RI
3" C/C
3 3/4" L



PA1322-RI
3" C/C, 4 3/8" L



PA1323-RI
3" C/C, 4 1/2" L

CRAFTSMAN

AVAILABLE FINISHES



CH WOA OBH BI



P2174-WOA
96MM C/C



P2172-WOA
Square Knob
1 1/4" SQ



P2170-WOA
Round Knob
1 1/4" Dia.



P2171-WOA
3" C/C



P2173-WOA
96MM C/C

| ITEM | MSRP |
|--------------|---------|
| P2170 | \$11.32 |
| P2171 | \$11.82 |
| P2172 | \$12.70 |
| P2173 | \$15.24 |
| P2174 | \$15.52 |

CREST

AVAILABLE FINISHES



SN CH FUB



H076127-CH
Square Knob
1 1/4" Dia.



H076128-CH
Round Knob
1 1/4" Dia.



H076129-CH
3" C/C
3 1/2" L



H076130-CH
96MM C/C
4" L



H076131-CH
128MM C/C
5 9/16" L



H076132-CH
160MM C/C
6 13/16" L



H076133-CH
192MM C/C
8 1/16" L



H076134-CH
224MM C/C
9 5/16" L

H076135-CH
12" C/C
12 1/2" L

| ITEM | MSRP |
|----------------|---------|
| H076127 | \$9.52 |
| H076128 | \$9.52 |
| H076129 | \$10.30 |
| H076130 | \$12.96 |
| H076131 | \$14.62 |
| H076132 | \$15.74 |
| H076133 | \$25.90 |
| H076134 | \$33.90 |
| H076135 | \$43.56 |

EURO CONTEMPORARY

AVAILABLE FINISHES



SN OBH



P2164-OBH
4" C/C
7" L

P2165-OBH
128MM C/C
9" L



P2163-OBH
Square knob
1 1/2" SQ

| ITEM | MSRP |
|-------|---------|
| P2163 | \$12.96 |
| P2164 | \$16.90 |
| P2165 | \$17.16 |

FORGE

AVAILABLE FINISHES



SN CH BGB CP VB BI

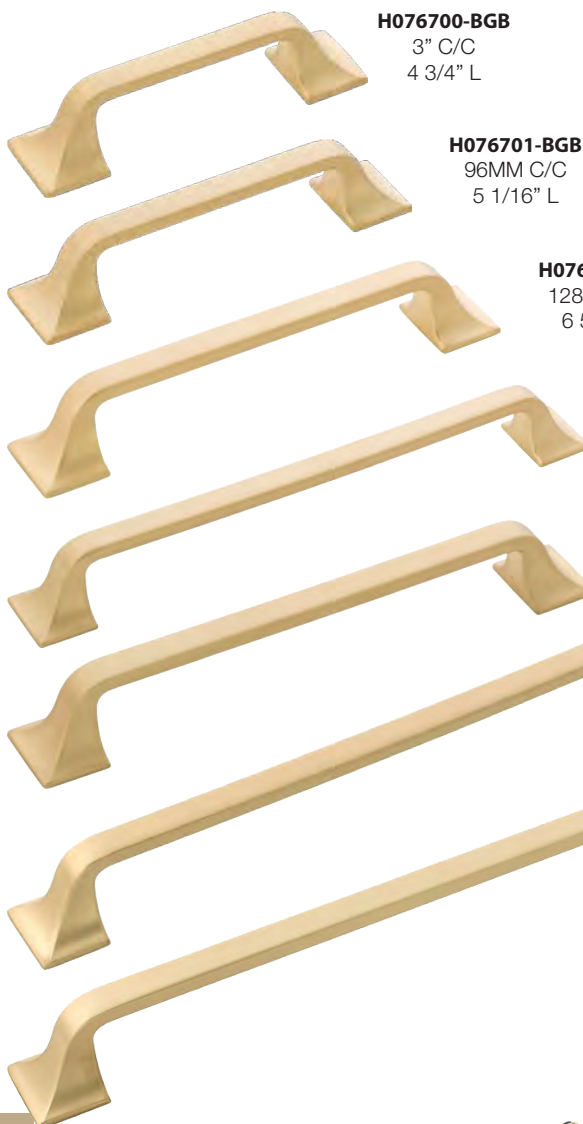

H076700-BGB
3" C/C
4 3/4" L

H076701-BGB
96MM C/C
5 1/16" L

H076702-BGB
128MM C/C
6 5/16" L

H076704-BGB
192MM C/C
7 9/16" L

H076703-BGB
160MM C/C
7 5/8" L

H076705-BGB
224MM C/C
10 1/8" L

H076706-BGB
12" C/C
13 3/8" L



H076698-BGB
Round Knob
1 3/8" Dia.



H076699-BGB
Square Knob
1 7/16" Dia.

| ITEM | MSRP |
|---------|---------|
| H076698 | \$10.30 |
| H076699 | \$11.06 |
| H076700 | \$11.82 |
| H076701 | \$13.60 |
| H076702 | \$16.90 |
| H076703 | \$23.62 |
| H076704 | \$33.52 |
| H076705 | \$50.30 |
| H076706 | \$63.76 |

GREENWICH

AVAILABLE FINISHES



14 SS WOA 10B



P3370-SS
96MM C/C
4 1/4" L



P3371-SS
128MM C/C
6 3/8" L



P3041-SS
224MM C/C
10" L



P3374-SS
12" C/C
13 1/4" L



P3375-SS
18" C/C
19 1/4" L



P3372-SS
Knob
1 11/16" Dia.

| ITEM | MSRP |
|--------------|---------|
| P3041 | \$23.62 |
| P3370 | \$12.08 |
| P3371 | \$16.36 |
| P3372 | \$9.76 |
| P3374 | \$50.52 |
| P3375 | \$91.94 |

KNOBS

AVAILABLE FINISHES



SN MB



P2712-MB
Small Knob
1" Dia.



PA1218-MB
Large Knob
1 1/4" Dia.



PA1217-MB
Small Knob
1" Dia.

| ITEM | MSRP |
|---------------|--------|
| P2712 | \$6.32 |
| PA1217 | \$6.60 |
| PA1218 | \$8.02 |

NOTE: P2712 is only available in MB Finish.

LUNA

AVAILABLE FINISHES



SN MB VB



P3448-VB
3" C/C
4 1/8" L

| ITEM | MSRP |
|--------------|--------|
| P3448 | \$8.38 |

MANCHESTER

AVAILABLE FINISHES

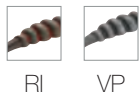

P2014-RI
2 1/8" L X 1 1/2"W



P2023-RI
96MM C/C
4 1/8" L

| ITEM | MSRP |
|-------|---------|
| P2014 | \$12.84 |
| P2023 | \$13.60 |

MANOR HOUSE

AVAILABLE FINISHES

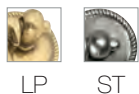

MOCK KEY
P321-ST
1" PROJ



P329-ST
3" C/C



P8049-ST
3" C/C, 4" L



BACKPLATE
P326-ST
5 1/2" L X 1" W

| ITEM | MSRP |
|-------|---------|
| P321 | \$6.60 |
| P326 | \$10.30 |
| P329 | \$17.52 |
| P8049 | \$16.00 |

NOTE: P321, P326, and P329 are not available in DAC Finish.

BELWITH

METROPOLIS

AVAILABLE FINISHES



P2922-SN
96MM C/C



P2921-SN
2 9/16" C/C



PA0221-SN
96MM C/C, 4 3/4" L



P7522-SN
96MM C/C, 5 1/2" L



P3221-SN
128MM C/C, 6 3/8" L



P7523-SN
Oblong Knob
1 5/8" L



PA0213-SN
Small Knob
1" Dia.

| ITEM | MSRP |
|--------|---------|
| P2921 | \$8.38 |
| P2922 | \$8.78 |
| P7522 | \$12.08 |
| P7523 | \$7.50 |
| PA0213 | \$8.78 |
| PA0221 | \$8.52 |

NOTE: PA0221, P3221, P7522 and P7523 are only available in SN Finish.

MOUNTAIN LODGE

AVAILABLE FINISHES



P3062-WOA
Square Knob
1 1/4" SQ



P3063-WOA
Round Knob
1 1/4" Dia.



P3061-WOA
Round Knob
1 1/4" Dia.

| ITEM | MSRP |
|-------|---------|
| P3060 | \$13.60 |
| P3061 | \$12.58 |
| P3062 | \$11.82 |
| P3063 | \$12.58 |
| P3064 | \$15.24 |



P3060-WOA
3" C/C

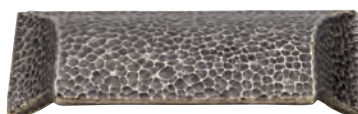

P3064-WOA
96MM C/C

PIPELINE

AVAILABLE FINISHES

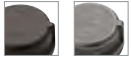

VB BNV



HH075028
1 1/4" Dia.



HH076013-BNV
3" C/C, 3 3/4" L



HH076011-BNV
96mm C/C, 4 1/2" L



HH076012-BNV
128mm C/C, 5 3/4" L



HH075010-BNV
160mm C/C, 7" L

| ITEM | MSRP |
|----------|---------|
| HH075010 | \$25.90 |
| HH075028 | \$11.06 |
| HH076011 | \$18.28 |
| HH076012 | \$21.84 |
| HH076013 | \$14.72 |

RALEIGH

AVAILABLE FINISHES



PN SN WOA OBH



P3111-WOA
5" C/C, 5 3/4" L

| ITEM | MSRP |
|-------|---------|
| P3111 | \$16.00 |

REFINED RUSTIC

AVAILABLE FINISHES



RI BL



P3002-BL
1 1/4" Dia.



P3003-BL
1 1/2" Dia.



P3001-BL
3" C/C, 4 3/4" L



P3000-BL
96MM C/C, 5 1/2" L



P3004-BL
3" & 96MM C/C, 5 1/2" L

| ITEM | MSRP |
|-------|---------|
| P3000 | \$15.12 |
| P3001 | \$12.08 |
| P3002 | \$12.70 |
| P3003 | \$13.20 |
| P3004 | \$16.50 |

ROCHESTER

AVAILABLE FINISHES



PN SN OBH



P3112-SN
96 MM C/C, 4 1/4" L



P3114-SN
96 MM C/C, 4 1/8" L

| ITEM | MSRP |
|-------|---------|
| P3112 | \$13.20 |
| P3114 | \$11.68 |

SOMERSET

AVAILABLE FINISHES



SN BNV DAC



74554-DAC
1 1/8" SQ

| ITEM | MSRP |
|-------|--------|
| 74554 | \$7.22 |

SKYLIGHT

AVAILABLE FINISHES



14 SS EGN BGB VB

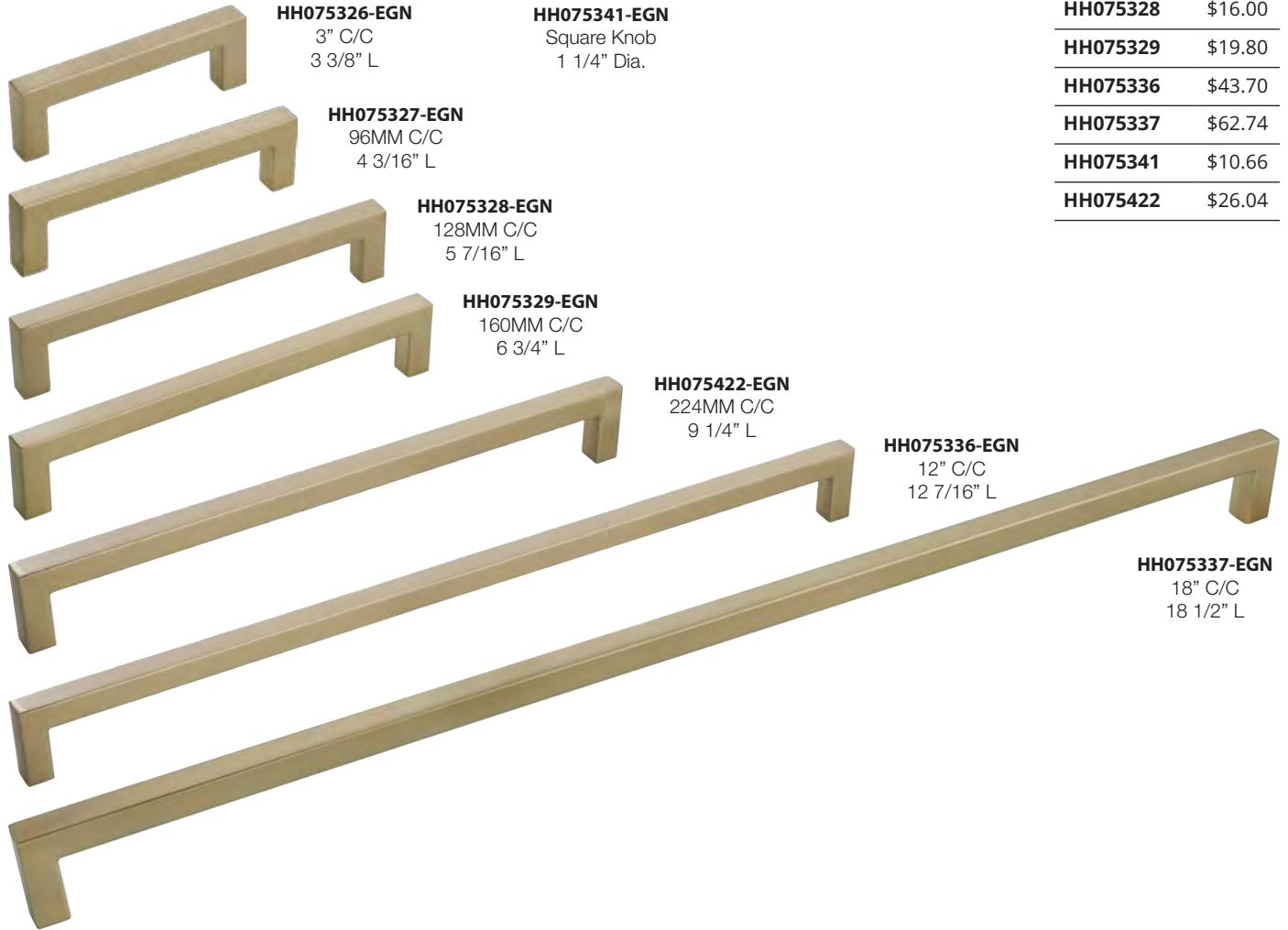

HH075326-EGN
3" C/C
3 3/8" L

HH075341-EGN
Square Knob
1 1/4" Dia.

HH075327-EGN
96MM C/C
4 3/16" L

HH075328-EGN
128MM C/C
5 7/16" L

HH075329-EGN
160MM C/C
6 3/4" L

HH075422-EGN
224MM C/C
9 1/4" L

HH075336-EGN
12" C/C
12 7/16" L

HH075337-EGN
18" C/C
18 1/2" L

| ITEM | MSRP |
|----------|---------|
| HH075326 | \$11.06 |
| HH075327 | \$13.60 |
| HH075328 | \$16.00 |
| HH075329 | \$19.80 |
| HH075336 | \$43.70 |
| HH075337 | \$62.74 |
| HH075341 | \$10.66 |
| HH075422 | \$26.04 |

BELWITH

STUDIO

AVAILABLE FINISHES



PN SN BGG CP VBZ OBH



P3010-OBH
3" C/C

P3014-OBH
Small Knob
1" SQ

P3011-OBH
96MM C/C

P3015-OBH
Large Knob
1 1/4" SQ

P3013-OBH
3" & 96MM C/C

| ITEM | MSRP |
|-------|---------|
| P3010 | \$13.96 |
| P3011 | \$15.88 |
| P3013 | \$15.26 |
| P3014 | \$11.56 |
| P3015 | \$12.08 |

NOTE: P3014 is only available in PN, SN, and OBH Finishes.

TWIST

AVAILABLE FINISHES



BI SN EGN PN CP



H076014-CP
1 1/4" Dia.



H076015-CP
3" C/C
3 5/8" L



H076016-CP
96mm C/C
4 7/16" L



H076017-CP
128mm C/C
5 11/16" L



H076018-CP
160mm C/C
6 15/16" L



H076019-CP
192mm C/C
8 1/4" L



H076020-CP
224mm C/C
9 9/16" L



H076021-CP
12" C/C
12 11/16" L

| ITEM | MSRP |
|---------|---------|
| H076014 | \$10.52 |
| H076015 | \$12.58 |
| H076016 | \$14.72 |
| H076017 | \$18.82 |
| H076018 | \$25.90 |
| H076019 | \$39.74 |
| H076020 | \$48.64 |
| H076021 | \$66.66 |

BELWITH

ZEPHYR

AVAILABLE FINISHES



SN OBH SS



P2286-SN
Small Knob
1" Dia.



P2283-SN
Large Knob
1 1/4" Dia.



P2280-SN
3" C/C



P2281-SN
96MM C/C



P2282-SN
128MM C/C

| ITEM | MSRP |
|-------|---------|
| P2280 | \$9.76 |
| P2281 | \$12.08 |
| P2282 | \$16.64 |
| P2283 | \$12.96 |
| P2286 | \$10.30 |

CRAFTSMAN

AVAILABLE FINISHES



CH WOA BI OBH

| ITEM | MSRP |
|-------|---------|
| P2175 | \$25.92 |

P2175-BI
HOOK
1 3/8" C/C
5 1/16" L X 2" W



BUNGALOW

AVAILABLE FINISHES



SN WOA OBH 10B PN

| ITEM | MSRP |
|-------|---------|
| P2155 | \$26.52 |

P2155-WOA
HOOK
1 1/2" C/C
5" L X 2" W



FORGE SIGNATURE HOOKS

AVAILABLE FINISHES



SN CH BGB BI

| ITEM | MSRP |
|---------|---------|
| S077190 | \$14.22 |

S077190-BGB
HOOK
1 1/2" C/C
2 3/4" L X 2" W



PIPELINE SIGNATURE HOOKS

AVAILABLE FINISHES



BNV VB

| ITEM | MSRP |
|---------|---------|
| S077188 | \$12.84 |

S077190-BGB
HOOK
1 1/2" C/C
2 1/2" L X 1 1/8" W



SKYLIGHT SIGNATURE HOOKS

AVAILABLE FINISHES



14 SS BGR VR

| ITEM | MSRP |
|---------|---------|
| S077192 | \$12.84 |

S077192-14
HOOK
1" C/C
4 7/8" L X 1 1/22" W

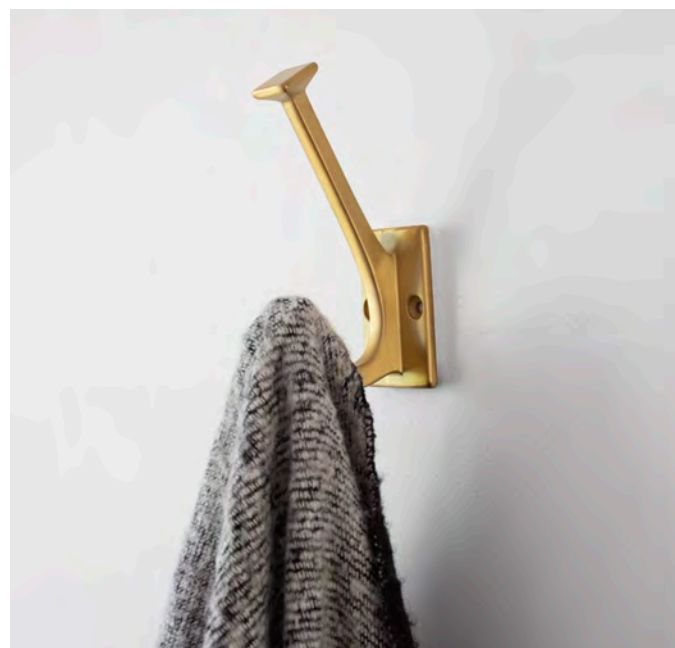

JEFFREY ALEXANDER®
by Hardware Resources

Aberdeen

AVAILABLE FINISHES

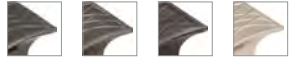

BNB BNBDL DBAC SN



535-BNB
Square Knob
1 1/4" Dia.



535L-BNB
Oblong Knob
1 1/2" Dia.



535-96-BNB
3 3/4" CC
5" Long



536-96-BNB
3 3/4" CC cup pull
5" Long



535-128-BNB
5" CC
6 1/4" Long



536-128-BNB
5" CC cup pull
6 1/4" Long



535-160-BNB
6 1/4" CC
5 5/8" Long

| Item | MSRP |
|----------------|---------|
| 535 | \$8.22 |
| 535L | \$8.22 |
| 535-96 | \$14.62 |
| 536-96 | \$16.44 |
| 535-128 | \$20.28 |
| 536-128 | \$24.00 |
| 535-160 | \$25.00 |

Alvar

AVAILABLE FINISHES



PC BNBDL DBAC SN NI SBZ



264-3-SBZ
3" CC
3 11/16" Long



264-96-SBZ
3 3/4" CC
5 7/16" Long



264-128-SBZ
5" CC
5 3/4" Long



264-160-SBZ
6 1/4" CC
7" Long



264-192-SBZ
7 9/16" CC
8 1/4" Long

| Item | MSRP |
|----------------|---------|
| 264-3 | \$5.82 |
| 264-96 | \$6.56 |
| 264-128 | \$7.56 |
| 264-160 | \$9.40 |
| 264-192 | \$11.26 |

Amsden

AVAILABLE FINISHES



DP DMAC DBAC SN NI



613-DMAC
Small Knob
1 7/16" Dia.



613L-DMAC
Large Knob
1 5/8" Dia.



613-96-DMAC
3 3/4" CC
4 3/8" Long



613-128-DMAC
5" CC
5 5/8" Long



613-160-DMAC
6 1/4" CC
6 7/8" Long

| Item | MSRP |
|----------------|---------|
| 613 | \$3.74 |
| 613L | \$4.58 |
| 613-96 | \$6.18 |
| 613-128 | \$9.40 |
| 613-160 | \$11.36 |

Annadale

AVAILABLE FINISHES

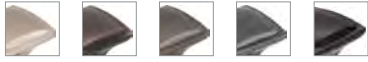

SN DBAC BNBDL DACM MB



435-DACM
Square knob
1 1/4" Dia.



435L-DACM
Oblong knob
1 1/2" Dia.

| Item | MSRP |
|----------------|---------|
| 435 | \$7.90 |
| 435L | \$7.90 |
| 435-96 | \$11.74 |
| 436-96 | \$14.62 |
| 435-128 | \$18.36 |
| 436-128 | \$22.14 |
| 435-160 | \$23.08 |



435-96-DACM
3 3/4" CC
5" Long



435-128-DACM
5" CC
6 1/4" Long



435-160-DACM
6 1/4" CC
7 5/8" Long



436-96-DACM
3 3/4" CC cup pull
5" Long



436-128-DACM
5" CC cup pull
6 1/4" Long

Anwick

AVAILABLE FINISHES



BNBDL DBAC NI SN



867-SN
Oblong Knob
1 3/8" Dia.



867L-SN
Square Knob
1 1/8" Dia.

| Item | MSRP |
|----------------|---------|
| 867 | \$7.26 |
| 867L | \$7.48 |
| 867-3 | \$8.90 |
| 867-96 | \$11.26 |
| 867-128 | \$15.68 |
| 867-160 | \$19.80 |
| 867-228 | \$25.38 |
| 867-320 | \$50.52 |



867-3-SN
3" CC
4 5/16" Long



867-96-SN
3 3/4" CC
5 1/8" Long



867-128-SN
5" CC
6 3/8" Long



867-160-SN
6 1/4" CC
7 5/8" Long



867-228-SN
9" CC
10 5/16" Long



867-320-SN
12 5/8" CC
13 15/16" Long

Audrey – NEW!

AVAILABLE FINISHES



MB BNBDL DBAC SBZ BG SN PC

| Item | MSRP |
|----------------|----------|
| 278 | \$5.50 |
| 278L | \$7.42 |
| 278-96 | \$8.12 |
| 278-128 | \$9.76 |
| 278-160 | \$12.12 |
| 278-192 | \$13.38 |
| 278-224 | \$16.96 |
| 278-12 | \$112.52 |
| 278-305 | \$44.92 |
| 278-18 | \$141.24 |



278-96-SBZ
96MM CC
4 1/4" Long



278-128-SBZ
128MM CC
5 9/16" Long



278-160-SBZ
160MM CC
6 13/16" Long



278-192-SBZ
192MM CC
8 1/16" Long



278-224-SBZ
224MM CC
9 3/8" Long



278-12-SBZ
12" CC
12 5/8" Long



278-305-SBZ
305MM CC
12 9/16" Long



278-18-SBZ
18" CC
18 3/4" Long



278-SN
Square Knob
1 1/8" Dia.



278L-SBZ
Square Knob
1 3/8" Dia.

JEFFREY ALEXANDER

Belcastel 1

AVAILABLE FINISHES

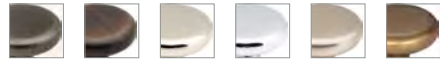

BNBDL DBAC NI PC SN SBZ

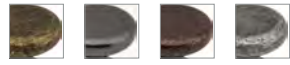

ABM-D DACM DMAC SIM-D



MO6303-BNBDL
Knob
1 3/8" Dia.

| Item | MSRP |
|-------------------|----------|
| MO6303 | \$5.80 |
| MO6373 | \$7.26 |
| MO6373-128 | \$9.50 |
| MO6373-160 | \$11.46 |
| MO6373-12 | \$119.26 |
| MO6373-18 | \$149.70 |



MO6373-BNBDL
3 3/4" CC
4 5/8" Long



MO6373-128-BNBDL
5" CC
5 7/8" Long



MO6373-160-BNBDL
6 1/4" CC
7 1/8" Long



MO6373-12-BNBDL
12" CC appliance pull
13 1/4" Long



MO6373-18-BNBDL
18" CC appliance pull
19 1/4" Long

JEFFREY ALEXANDER®

by Hardware Resources

Bella

AVAILABLE FINISHES



ABSB BNBDL DBAC NI SN



818-ABSB
Round Knob
1 3/8" Dia.



818L-ABSB
T Knob
2 1/4" Dia.

| Item | MSRP |
|----------------|----------|
| 818 | \$9.38 |
| 818L | \$12.32 |
| 818-96 | \$14.56 |
| 818-128 | \$16.70 |
| 818-160 | \$21.38 |
| 818-12 | \$128.32 |



818-96-ABSB
3 3/4" CC
4 3/8" Long



818-128-ABSB
5" CC
5 11/16" Long



818-160-ABSB
6 1/4" CC
6 15/16" Long



818-12-ABSB
12" CC appliance pull
13 1/8" Long

JEFFREY ALEXANDER

Bienville

AVAILABLE FINISHES



ABSB BNBDL DBAC



959-BNBDL
Knob
1 5/16" Dia.



959-96-BNBDL
3 3/4" CC
5 13/16" Long

| Item | MSRP |
|---------------|---------|
| 959 | \$7.74 |
| 959-96 | \$10.98 |

Bordeaux

AVAILABLE FINISHES

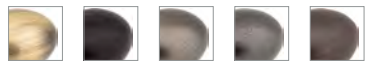

AB BLK BNBDL DACM DBAC



NI ORB PC SIM SN



3990-ORB
Egg Knob
1 3/16" Dia.



8236-ORB
3 3/4" CC
5" Long

| Item | MSRP |
|-------------|--------|
| 3990 | \$5.40 |
| 8236 | \$6.50 |

Boswell

AVAILABLE FINISHES



MB BNBDL DBAC PC SN



177-96
96MM CC
4 1/4" Long



177-128
128MM CC
5 9/16" Long



177-160
160MM CC
6 13/16" Long



177-192
192MM CC
8 1/16" Long



177-224
224MM CC
9 5/16" Long

| Item | MSRP |
|----------------|---------|
| 177-96 | \$6.36 |
| 177-128 | \$8.38 |
| 177-160 | \$10.50 |
| 177-192 | \$12.60 |
| 177-224 | \$14.76 |



MO6373-18-PC
Belcastel

MO6373-160-PC
Belcastel

Bremen 1

AVAILABLE FINISHES



BNBDL DBAC NI PC SN SBZ



ABM-D ABSB DACM DMAC SIM



117-DACM
Knob
1 1/4" Dia.

| Item | MSRP |
|----------------|----------|
| 117 | \$4.36 |
| 527 | \$8.80 |
| 527-128 | \$10.14 |
| 527-160 | \$13.08 |
| 527-12 | \$119.26 |



527-DACM
96MM CC
4 5/8" Long



527-128-DACM
5" CC
5 7/8" Long



527-160-DACM
6 1/4" CC
7 1/8" Long



527-12-DACM
12" CC appliance pull
13 1/16" Long

JEFFREY ALEXANDER

535L-BNBDL
Aberdeen

535-128-BNBDL
Aberdeen



Bremen 2

AVAILABLE FINISHES



ABSB DACM DBAC DMAC NI SN



127-NI
Knob (barrel)
1 3/16" Dia.



137-NI
Knob (stacked)
1 1/4" Dia.

| Item | MSRP |
|----------------|----------|
| 127 | \$5.80 |
| 137 | \$4.36 |
| 537 | \$7.26 |
| 537-128 | \$8.76 |
| 537-160 | \$10.12 |
| 537-12 | \$119.26 |



537-NI
3 3/4" CC
4 3/16" Long



537-128-NI
5" CC
5 7/16" Long



537-160-NI
6 1/4" CC
6 9/16" Long



537-12-NI
12" CC appliance pull
12 11/16" Long

Cairo

AVAILABLE FINISHES

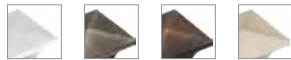

PC BNBDL DBAC SN

595-SN
Knob
1 1/4" Dia.



| Item | MSRP |
|----------------|--------|
| 595 | \$4.36 |
| 595-96 | \$5.96 |
| 595-128 | \$7.14 |



595-96-SN
3 3/4" CC
4 13/16" Long



595-128-SN
5" CC
6 1/16" Long

Callie

AVAILABLE FINISHES



BNBDL DBAC NI PC SN



839-3-PC
3" CC
4 3/16" Long

839-96-PC
3 3/4" CC
4 15/16" Long

839-128-PC
5" CC
6 1/4" Long

839-160-PC
6 1/4" CC
7 1/2" Long

| Item | MSRP |
|----------------|---------|
| 839-3 | \$6.88 |
| 839-96 | \$8.98 |
| 839-128 | \$10.72 |
| 839-160 | \$12.84 |

Chesapeake

AVAILABLE FINISHES



ABSB BNBDL BNDL DACM DBAC SIM SN



915-BNBDL
Knob
1 5/16" Dia.

Z110-BNBDL
Knob
1 3/16" Dia.



737-96-BNBDL
3 3/4" CC
4 1/4" Long

737-128-BNBDL
5" CC
5 1/2" Long

737-160-BNBDL
6 1/4" CC
6 3/4" Long

737-12-BNBDL
12" CC appliance pull
12 15/16" Long

| Item | MSRP |
|----------------|----------|
| 915 | \$5.06 |
| Z110 | \$3.14 |
| 737-96 | \$6.88 |
| 737-128 | \$8.68 |
| 737-160 | \$10.50 |
| 737-12 | \$119.26 |

NOTE: BNDL Finish is only available on Z110.

JEFFREY ALEXANDER®

by Hardware Resources

Cordova

AVAILABLE FINISHES



ABSB BNDL DBAC SN



0251-SN
Knob
1 3/8" Dia.



Z110-SN
Knob
1 3/16" Dia.



Z111-SN
Knob
1 1/4" Dia.

| Item | MSRP |
|-----------------|----------|
| 0251 | \$4.22 |
| Z110 | \$3.14 |
| Z111 | \$4.16 |
| Z281 | \$5.72 |
| Z280 | \$7.00 |
| Z281-128 | \$9.98 |
| Z281-160 | \$12.90 |
| Z281-12 | \$119.26 |
| Z281-18 | \$149.70 |

NOTE: 0251 is also available in BNDL Finish. Z110 is also available in BNDL, DACM or SIN Finishes. 0251 is not available in BNDL.



Z281-SN
3" CC
3 3/8" Long



Z280-SN
3 3/4" CC
4 3/16" Long



Z281-128-SN
5" CC
5 7/16" Long



Z281-160-SN
6 1/4" CC
6 11/16" Long



Z281-12-SN
12" CC appliance pull
12 3/4" Long



Z281-18-SN
18" CC appliance pull
18 3/4" Long

JEFFREY ALEXANDER

Delgado

AVAILABLE FINISHES



BNBDL ABSB DBAC NI SN



519-96-NI
3 3/4" CC
4 1/4" Long



519-128-NI
5" CC
5 9/16" Long



519-160-NI
6 1/4" CC
6 13/16" Long

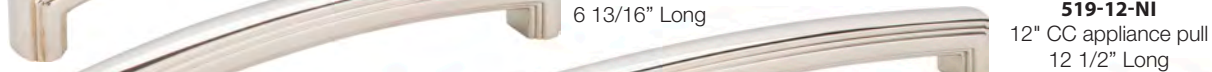

519-12-NI
12" CC appliance pull
12 1/2" Long



519-18-NI
18" CC appliance pull
18 1/2" Long



519-NI
Knob
1 9/16" Dia.

| Item | MSRP |
|----------------|----------|
| 519 | \$8.10 |
| 519-96 | \$14.44 |
| 519-128 | \$24.04 |
| 519-160 | \$30.36 |
| 519-12 | \$128.32 |
| 519-18 | \$158.28 |

Delmar

AVAILABLE FINISHES



SN DBAC BNBDL DACM DP



585-96-DP
3 3/4" CC
4 1/2" Long



585-DP
Small knob
1" Dia.



585L-DP
Large knob
1 1/4" Dia.



585-128-DP
5" CC
5 13/16" Long



585-160-DP
6 1/4" CC
7 1/16" Long



585-12-DP
12" appliance pull
13 1/4" Long

| Item | MSRP |
|----------------|----------|
| 585 | \$8.20 |
| 585L | \$10.24 |
| 585-96 | \$12.90 |
| 585-128 | \$20.64 |
| 585-160 | \$26.56 |
| 585-12 | \$141.16 |

Dominique

AVAILABLE FINISHES



845-BNBDL
Knob
1 1/8" Dia.



845T-BNBDL
Knob
2" Dia.



845TL-BNBDL
Knob
2 1/4" Dia.



845-96-BNBDL
3 3/4" CC
5 3/4" Long



845-128-BNBDL
5" CC
7 1/16" Long



845-160-BNBDL
6 1/4" CC
8 5/16" Long



845-192-BNBDL
7 1/2" CC
9 9/16" Long



845-305-BNBDL
12" CC
14" Long



845-12-BNBDL
12" CC
15" Long



845-18-BNBDL
18" CC
21" Long

| Item | MSRP |
|----------------|----------|
| 845 | \$4.68 |
| 845T | \$5.32 |
| 845TL | \$5.56 |
| 845-96 | \$7.84 |
| 845-128 | \$9.38 |
| 845-160 | \$11.48 |
| 845-192 | \$12.84 |
| 845-305 | \$54.72 |
| 845-12 | \$119.26 |
| 845-18 | \$149.70 |

JEFFREY ALEXANDER®

by Hardware Resources

Durham

AVAILABLE FINISHES



3980-DBAC
Knob
1 1/4" Dia.

| Item | MSRP |
|-----------------|----------|
| 3980 | \$5.40 |
| Z290-3 | \$4.28 |
| Z290-96 | \$5.38 |
| Z290-128 | \$11.46 |
| Z290-160 | \$13.02 |
| Z290-12 | \$119.26 |



Z290-3-DBAC
3" CC
3 3/8" Long



Z290-96-DBAC
3 3/4" CC
4 1/4" Long



Z290-128-DBAC
5" CC
5 1/2" Long



Z290-160-DBAC
6 1/4" CC
6 3/4" Long



Z290-12-DBAC
12" CC
13" Long

Duval

AVAILABLE FINISHES



343-BNBDL
Knob
1 1/4" Dia.

| Item | MSRP |
|----------------|----------|
| 343 | \$9.60 |
| 343-96 | \$13.24 |
| 343-128 | \$18.08 |
| 343-160 | \$20.04 |
| 343-12 | \$149.70 |



343-96-BNBDL
3 3/4" CC
4 1/2" Long



343-128-BNBDL
5" CC
5 13/16" Long



343-160-BNBDL
6 1/4" CC
7 1/16" Long



343-12-BNBDL
12" CC appliance pull
13 1/8" Long

JEFFREY ALEXANDER

Elara

AVAILABLE FINISHES

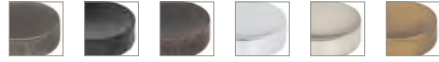

BNBDL MB DBAC PC SN SBZ



484-32-SBZ
32MM CC
2 1/16" Long



484-396-SBZ
3" or 96MM CC
4 9/16" Long



484-128160-SBZ
128MM or 160MM CC
7 1/8" Long

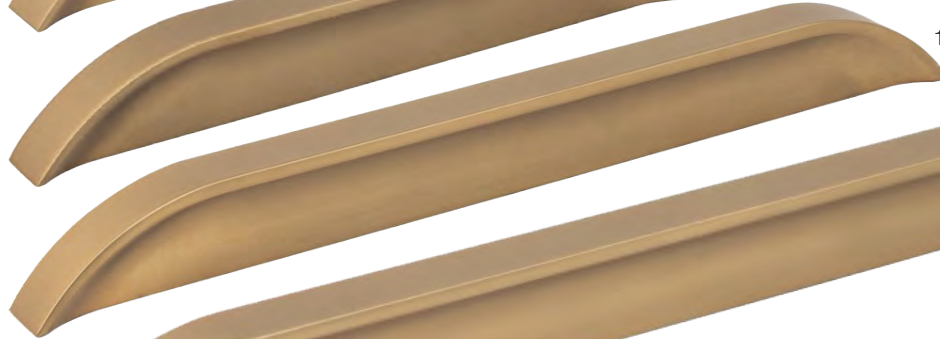

484-192224-SBZ
192MM or 224MM CC
9 5/8" Long



484-305-SBZ
305MM CC
12 13/16" Long



484-SBZ
Knob
1 1/4" Dia.

| Item | MSRP |
|-------------------|---------|
| 484 | \$4.58 |
| 484-32 | \$5.66 |
| 484-396 | \$9.18 |
| 484-128160 | \$12.70 |
| 484-192224 | \$17.80 |
| 484-305 | \$54.72 |

Ella

AVAILABLE FINISHES



NI DBAC SN PC BNBDL



165-96-BNBDL
3 3/4" CC
4 1/2" Long



165-BNBDL
Knob
1 1/4" Dia.



165-128-BNBDL
5" CC
5 13/16" Long



165-160-BNBDL
6 1/4" CC
7 1/16" Long



165-12-BNBDL
12" CC
13" Long

| Item | MSRP |
|----------------|----------|
| 165 | \$6.82 |
| 165-96 | \$11.74 |
| 165-128 | \$14.46 |
| 165-160 | \$17.40 |
| 165-12 | \$128.32 |

Glenmore

AVAILABLE FINISHES



ABSB BNMDL DACM DBAC



618-BNMDL
Small Knob
2 5/8" Dia.



618L-BNMDL
Large Knob
2 15/16" Dia.



718-BNMDL
5" CC
5 3/4" Long



718-128-BNMDL
5" CC bail pull
5 15/16" Long

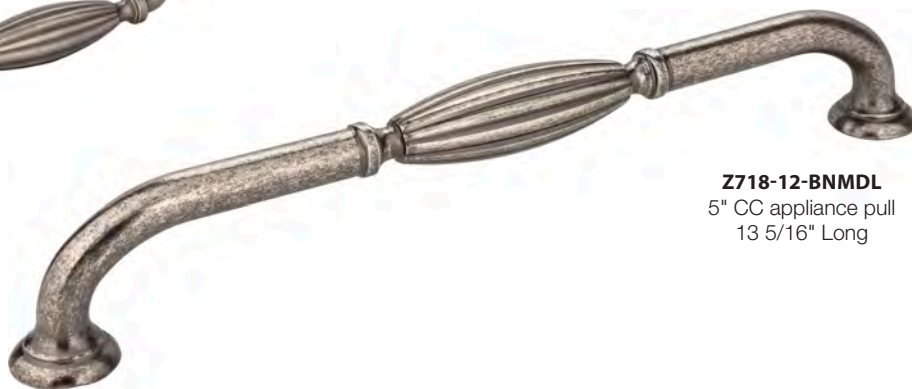

Z718-12-BNMDL
5" CC appliance pull
13 5/16" Long

| Item | MSRP |
|----------------|----------|
| 618 | \$5.06 |
| 618L | \$8.60 |
| 718 | \$10.02 |
| 718-128 | \$12.86 |
| Z718-12 | \$119.26 |

Harlow



G110-DBAC
Small egg
1 1/4" Dia.



G120-PC
Small button
1 7/16" Dia.



G130-DBAC
Small sphere
1 1/16" Dia.



G110L-BNBDL
Large egg
1 5/8" Dia.



G120L-SN
Large button
1 3/4" Dia.



G130L-BNBDL
Large sphere
1 3/8" Dia.



G140-BNBDL
Small square
1" Dia.



G140L-SN
Large square
1 3/8" Dia.



G150-DBAC
Small faceted
1" Dia.



G150L-PC
Large faceted
1 1/4" Dia.

| Item | MSRP |
|--------------|---------|
| G110 | \$12.58 |
| G110L | \$19.72 |
| G120 | \$12.58 |
| G120L | \$19.72 |
| G130 | \$12.58 |
| G130L | \$13.48 |
| G140 | \$12.58 |
| G140L | \$19.72 |
| G150 | \$10.82 |
| G150L | \$13.48 |

Hayworth

AVAILABLE FINISHES



NI PC SN



885-PC
Knob
1 1/8" Dia.



885L-PC
T Knob
2" Dia.



885-96-PC
3 3/4" CC
4 3/4" Long



885-128-PC
5" CC
6" Long



885-160-PC
6 1/4" CC
7 1/4" Long



885-192-PC
7 9/16" CC
8 1/2" Long



885-224-PC
8 13/16" CC
9 3/4" Long



885-305-PC
12" CC appliance pull
4 3/4" Long

| Item | MSRP |
|----------------|---------|
| 885 | \$6.30 |
| 885L | \$7.42 |
| 885-96 | \$11.30 |
| 885-128 | \$13.08 |
| 885-160 | \$15.26 |
| 885-192 | \$17.60 |
| 885-224 | \$19.94 |
| 885-305 | \$54.72 |



278-128-SBZ
Audrey

278-SBZ
Audrey

JEFFREY ALEXANDER

Hudson

AVAILABLE FINISHES

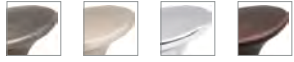

BNBDL SN PC DBAC



650-96-DBAC
3 3/4" CC
4 3/8" Long



650-128-DBAC
5" CC
5 5/8" Long



650-160-DBAC
6 1/4" CC
6 15/16" Long



650-12-DBAC
12" CC appliance pull
13" Long



650-DBAC
Knob
1 7/8" Dia.

| Item | MSRP |
|----------------|----------|
| 650 | \$5.70 |
| 650-96 | \$7.10 |
| 650-128 | \$8.68 |
| 650-160 | \$11.26 |
| 650-12 | \$119.26 |

Katharine

AVAILABLE FINISHES

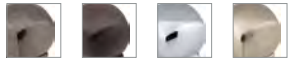

BNBDL DBAC PC SN



188-SN
Small Knob
7/8" Dia.



188L-SN
Large Knob
1" Dia.



188-96-SN
3 3/4" CC
4 3/8" Long



188-128-SN
5" CC
5 11/16" Long



188-160-SN
6 1/4" CC
6 15/16" Long

| Item | MSRP |
|----------------|---------|
| 188 | \$7.26 |
| 188L | \$8.06 |
| 188-96 | \$11.20 |
| 188-128 | \$14.84 |
| 188-160 | \$18.24 |

Key Grande – New Colors!

AVAILABLE FINISHES



MB MBBG BG MBSN SN

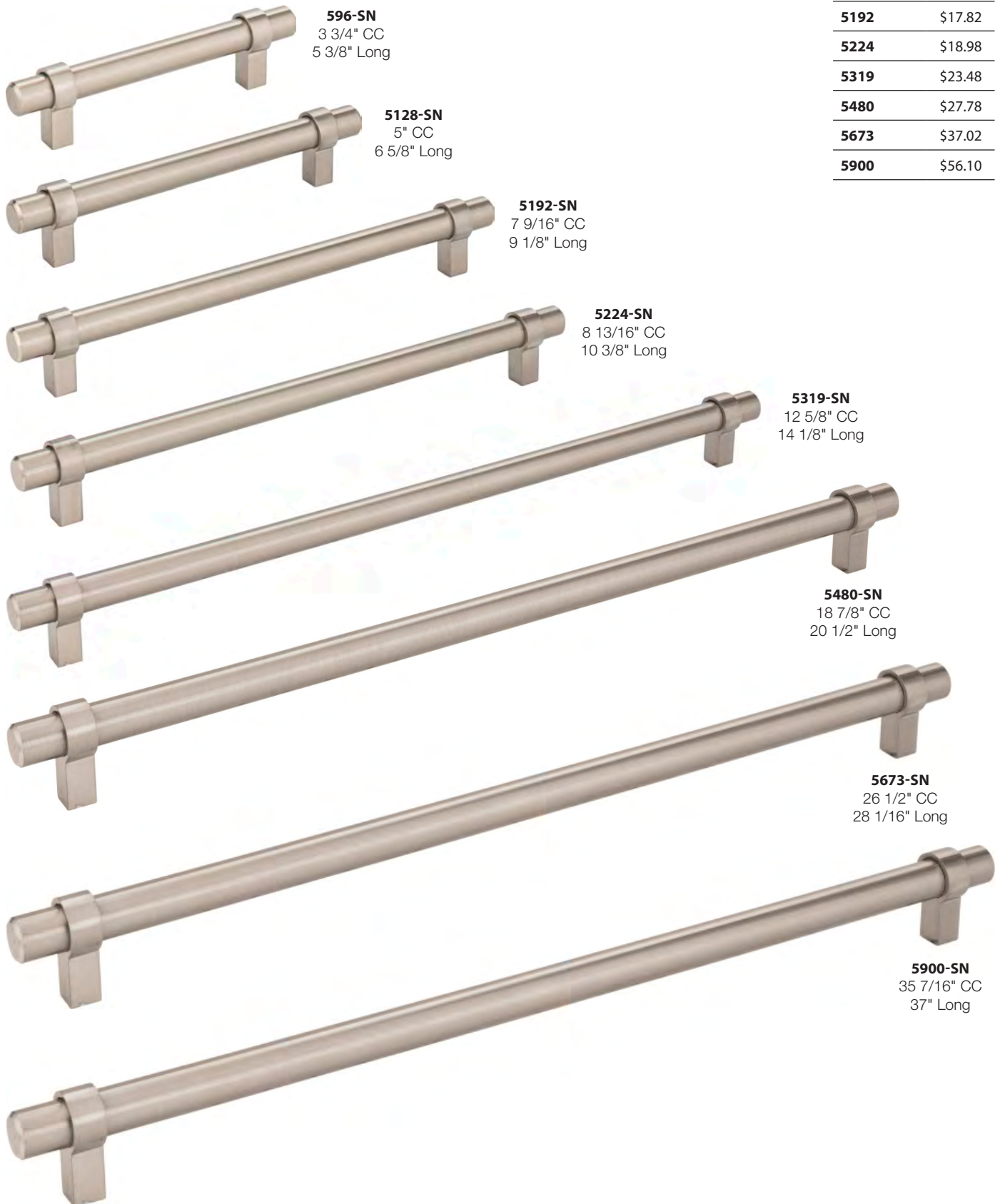

596-SN
3 3/4" CC
5 3/8" Long

5128-SN
5" CC
6 5/8" Long

5192-SN
7 9/16" CC
9 1/8" Long

5224-SN
8 13/16" CC
10 3/8" Long

5319-SN
12 5/8" CC
14 1/8" Long

5480-SN
18 7/8" CC
20 1/2" Long

5673-SN
26 1/2" CC
28 1/16" Long

5900-SN
35 7/16" CC
37" Long

| Item | MSRP |
|-------------|---------|
| 596 | \$13.24 |
| 5128 | \$14.76 |
| 5192 | \$17.82 |
| 5224 | \$18.98 |
| 5319 | \$23.48 |
| 5480 | \$27.78 |
| 5673 | \$37.02 |
| 5900 | \$56.10 |

Key West & Key Largo

AVAILABLE FINISHES

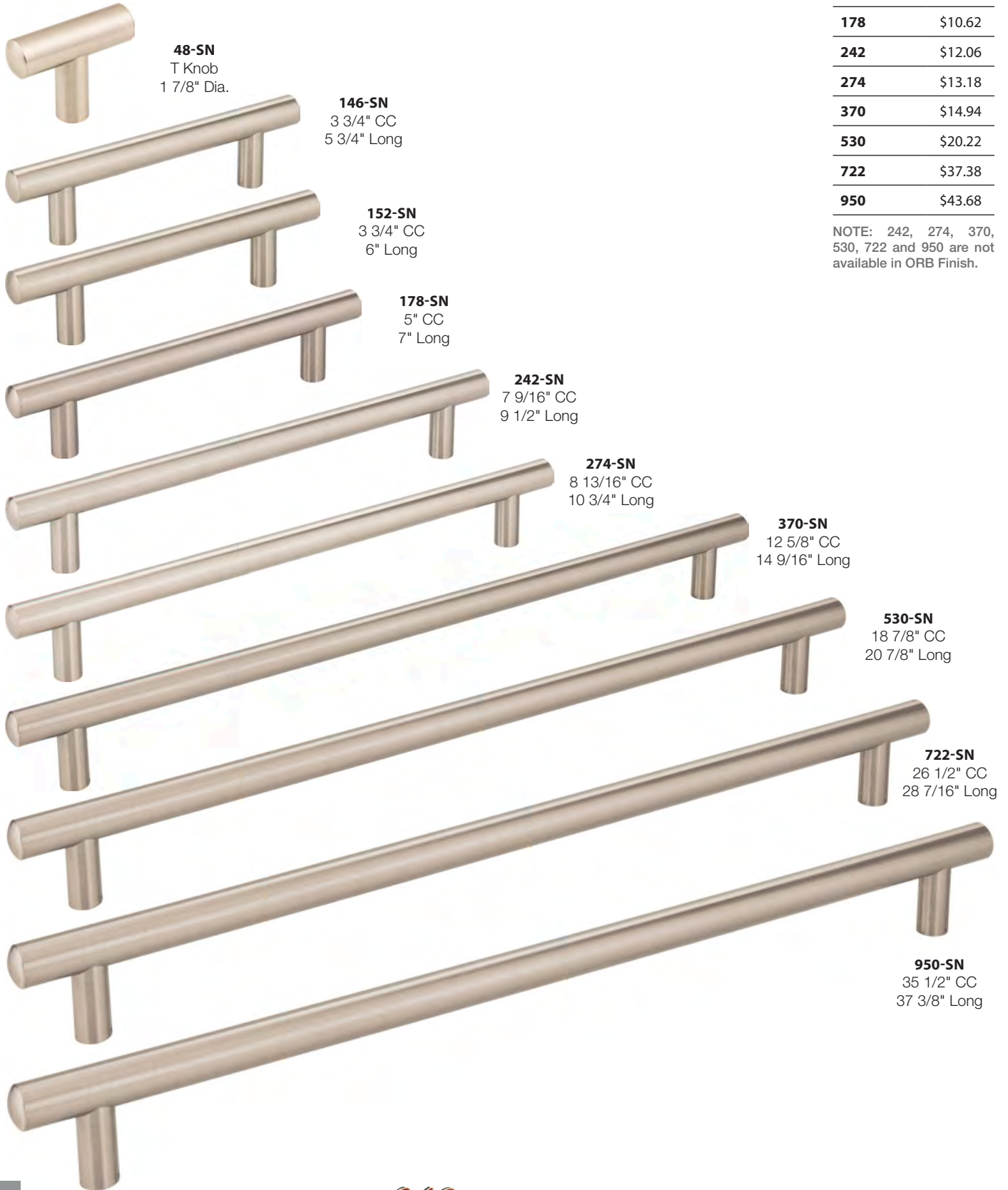

48-SN
T Knob
1 7/8" Dia.

146-SN
3 3/4" CC
5 3/4" Long

152-SN
3 3/4" CC
6" Long

178-SN
5" CC
7" Long

242-SN
7 9/16" CC
9 1/2" Long

274-SN
8 13/16" CC
10 3/4" Long

370-SN
12 5/8" CC
14 9/16" Long

530-SN
18 7/8" CC
20 7/8" Long

722-SN
26 1/2" CC
28 7/16" Long

950-SN
35 1/2" CC
37 3/8" Long

| Item | MSRP |
|------------|---------|
| 48 | \$4.48 |
| 146 | \$9.08 |
| 152 | \$9.56 |
| 178 | \$10.62 |
| 242 | \$12.06 |
| 274 | \$13.18 |
| 370 | \$14.94 |
| 530 | \$20.22 |
| 722 | \$37.38 |
| 950 | \$43.68 |

NOTE: 242, 274, 370, 530, 722 and 950 are not available in ORB Finish.

JEFFREY ALEXANDER®

by Hardware Resources

Lafayette

AVAILABLE FINISHES



ABSB BNBDL DBAC SN



218-DBAC
Fleur-de-lis Knob
1 3/8" Dia.



317-DBAC
Circles Knob
1 3/8" Dia.



417-DBAC
Baroque Knob
1 3/8" Dia.

| Item | MSRP |
|----------------|----------|
| 218 | \$9.38 |
| 317 | \$8.48 |
| 417 | \$8.92 |
| 317-96 | \$12.32 |
| 317-128 | \$13.70 |
| 317-160 | \$16.16 |
| 317-12 | \$141.16 |



317-96-DBAC
3 3/4" CC
4 3/8" Long



317-128-DBAC
5" CC
5 5/8" Long



317-160-DBAC
6 1/4" CC
6 7/8" Long

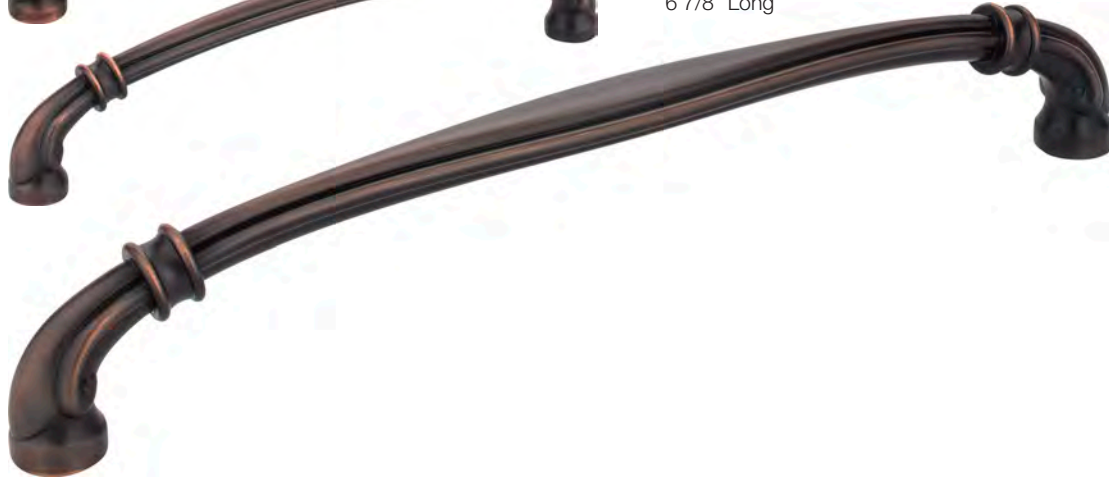

317-12-DBAC
12" CC appliance pull
12 15/16" Long

Lenoir

AVAILABLE FINISHES



ABSB BNBDL DACM DBAC MB ORB SIM SN

| Item | MSRP |
|-------------|--------|
| Z117 | \$4.28 |
| 8237 | \$5.06 |



Z117-ABSB
Knob
1 1/4" Dia.



8237-ABSB
3 3/4" CC
5" Long

JEFFREY ALEXANDER

Lexa

AVAILABLE FINISHES



BN BNBDL DBAC PC SN



259-BN
Knob
2" Dia.



259-96-BN
3 3/4" CC
4 3/16" Long



259-128-BN
5" CC
5 7/16" Long



259-160-BN
6 1/4" CC
6 11/16" Long



259-192-BN
7 9/16" CC
8" Long

| Item | MSRP |
|----------------|---------|
| 259 | \$7.56 |
| 259-96 | \$12.92 |
| 259-128 | \$15.46 |
| 259-160 | \$17.22 |
| 259-192 | \$20.28 |

Leyton

AVAILABLE FINISHES



BNBDL DBAC SN PC NI SBZ



286-96-SBZ
3 3/4" CC
5 1/8" Long



286-128-SBZ
5" CC
6 3/8" Long



286-160-SBZ
6 1/4" CC
7 11/16" Long



286-192-SBZ
7 9/16" CC
8 15/16" Long



286-224-SBZ
8 13/16" CC
10 3/16" Long

| Item | MSRP |
|----------------|---------|
| 286-96 | \$10.08 |
| 286-128 | \$11.40 |
| 286-160 | \$13.50 |
| 286-192 | \$15.80 |
| 286-224 | \$18.12 |

JEFFREY ALEXANDER®

by Hardware Resources

Lille

AVAILABLE FINISHES



ABSB BNBDL DACM DBAC SN



4155-DACM
Small Knob
1 1/4" Dia.



415-DACM
Large Knob
1 3/8" Dia.



415-96-DACM
3 3/4" CC
4 3/8" Long



415-96V-DACM
3 3/4" CC asymmetrical
4 3/4" Long



415-128-DACM
5" CC
5 5/8" Long



415-160-DACM
6 1/4" CC
6 7/8" Long



415-12-DACM
12" CC appliance pull
12 7/8" Long

| Item | MSRP |
|----------------|----------|
| 415S | \$7.24 |
| 415 | \$9.86 |
| 415-96 | \$8.68 |
| 415-96V | \$12.12 |
| 415-128 | \$14.46 |
| 415-160 | \$18.66 |
| 415-12 | \$119.26 |

Lyon

AVAILABLE FINISHES

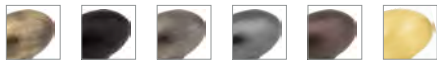

AB BLK BNBDL DACM DBAC BG



NI ORB PC SIM SN SBZ



3991-PC
Egg Knob
1 9/16" Dia.



8233-PC
3" CC
4 15/16" Long

| Item | MSRP |
|-------------|--------|
| 3991 | \$6.72 |
| 8233 | \$5.70 |

JEFFREY ALEXANDER

Marlo

AVAILABLE FINISHES



NI BNBDL DBAC PC SN



972S-SN
Small knob
7/8" Dia.



972-SN
Medium knob
1 1/8" Dia.



972L-SN
Large knob
1 1/4" Dia.

| Item | MSRP |
|----------------|----------|
| 972S | \$5.40 |
| 972 | \$6.56 |
| 972L | \$8.06 |
| 972-96 | \$11.40 |
| 972-128 | \$14.24 |
| 972-160 | \$20.36 |
| 972-224 | \$19.94 |
| 972-305 | \$54.72 |
| 972-12 | \$128.32 |



972-96-SN
3 3/4" CC
4 1/2" Long



972-128-SN
5" CC
5 13/16" Long



972-160-SN
6 1/4" CC
7 1/16" Long



972-224-SN
8 13/16" CC
9 3/4" Long



972-305-SN
12" CC
12 3/4" Long



972-12-SN
12" CC appliance pull
13" Long

JEFFREY ALEXANDER

Maybeck

AVAILABLE FINISHES



BN BNBDL DBAC PC SN



225-DBAC
Knob
1 11/16" Dia.

| Item | MSRP |
|----------------|---------|
| 225 | \$8.04 |
| 225-96 | \$16.32 |
| 225-128 | \$18.84 |
| 225-160 | \$21.86 |



225-96-DBAC
3 3/4" CC
5 1/4" Long



225-128-DBAC
5" CC
6 3/8" Long



225-160-DBAC
6 1/4" CC
7 7/16" Long

Merrick

AVAILABLE FINISHES



PC BNBDL DBAC SN MB SBZ



549-96-SN
3 3/4" CC
4 3/16" Long



549-128-SN
5" CC
5 1/2" Long



549-160-SN
6 1/4" CC
6 3/4" Long



549-192-SN
7 9/16" CC
8" Long



549-320-SN
12 5/8" CC
13 1/16" Long

| Item | MSRP |
|----------------|---------|
| 549-96 | \$6.28 |
| 549-128 | \$7.16 |
| 549-160 | \$8.10 |
| 549-192 | \$9.16 |
| 549-320 | \$24.16 |

JEFFREY ALEXANDER

Milan 1

AVAILABLE FINISHES



1091-SN
Knob
1 3/16" Dia.



1092-SN
3 3/4" CC
4 1/4" Long



1092-128-SN
5" CC
5 9/16" Long



1092-160-SN
6 1/4" CC
6 13/16" Long



1092-12-SN
12" CC
12 13/16" Long

| Item | MSRP |
|-----------------|----------|
| 1091 | \$7.14 |
| 1092 | \$8.04 |
| 1092-128 | \$10.92 |
| 1092-160 | \$13.12 |
| 1092-12 | \$119.26 |

Milan 2

AVAILABLE FINISHES



1093-AEM
Knob
1 3/16" Dia.



1094-AEM
3 3/4" CC
4 1/4" Long



1094-128-AEM
5" CC
5 9/16" Long



1094-160-AEM
6 1/4" CC
6 13/16" Long



1094-12-AEM
12" CC appliance pull
12 13/16" Long

| Item | MSRP |
|-----------------|----------|
| 1093 | \$7.72 |
| 1094 | \$9.60 |
| 1094-128 | \$12.48 |
| 1094-160 | \$13.34 |
| 1094-12 | \$114.02 |

Mirada

AVAILABLE FINISHES

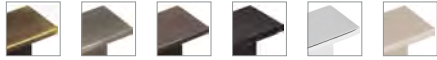

ABSB BNBDL DBAC MB PC SN



81021-PC
5/8" CC Knob
1 9/16" Dia.

| Item | MSRP |
|------------------|---------|
| 81021 | \$4.48 |
| 80152-96 | \$11.68 |
| 80152-128 | \$13.16 |
| 80152-160 | \$14.82 |



80152-96-PC
3 3/4" CC
5 9/16" Long



80152-128-PC
5" CC
6 13/16" Long



80152-160-PC
6 1/4" CC
8 1/16" Long

Montclair

AVAILABLE FINISHES



ABSB BNBDL DBAC SN



935-SN
Knob
2" Dia.

| Item | MSRP |
|----------------|----------|
| 935 | \$10.66 |
| 935-96 | \$14.82 |
| 935-128 | \$18.76 |
| 935-160 | \$20.48 |
| 935-12 | \$151.42 |



935-96-SN
3 3/4" CC
5 5/8" Long



935-128-SN
5" CC
7 1/2" Long



935-160-SN
6 1/4" CC
8 3/4" Long



935-12-SN
12" CC appliance pull
16" Long

JEFFREY ALEXANDER®

by Hardware Resources

Philip

AVAILABLE FINISHES



767-SBZ
Knob
1 1/4" Dia.

| Item | MSRP |
|----------------|---------|
| 767 | \$5.22 |
| 767-96 | \$6.04 |
| 767-128 | \$8.58 |
| 767-160 | \$10.52 |



767-96-SBZ
3 3/4" CC
5" Long



767-128-SBZ
5" CC
6 5/16" Long



767-160-SBZ
6 1/4" CC
7 9/16" Long

Prestige

AVAILABLE FINISHES



918-DP
Knob
1 3/8" Dia.



918L-DP
Knob
2 1/4" Dia.

| Item | MSRP |
|----------------|----------|
| 918 | \$11.62 |
| 918L | \$14.56 |
| 918-96 | \$16.70 |
| 918-128 | \$20.12 |
| 918-160 | \$24.70 |
| 918-12 | \$158.28 |



918-96-DP
3 3/4" CC
4 3/8" Long



918-128-DP
5" CC
5 11/16" Long



918-160-DP
6 1/4" CC
6 15/16" Long

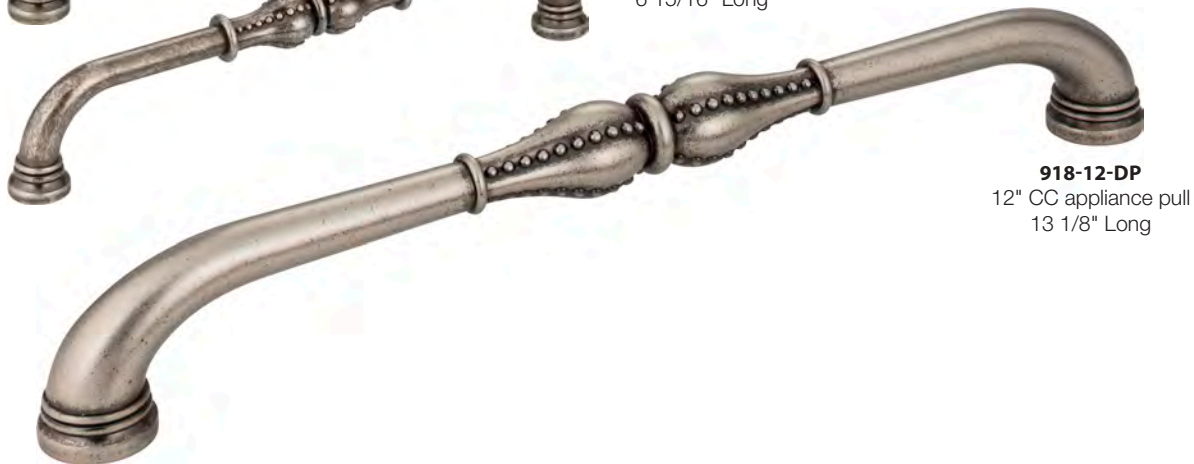

918-12-DP
12" CC appliance pull
13 1/8" Long

JEFFREY ALEXANDER

JEFFREY ALEXANDER®

by Hardware Resources

Rae

AVAILABLE FINISHES



BNBDL DBAC NI PC SN



667-3-NI
3" CC
3 7/16" Long



667-96-NI
3 3/4" CC
4 3/16" Long



667-128-NI
5" CC
5 1/2" Long



667-160-NI
6 1/4" CC
6 3/4" Long



667-224-NI
8 13/16" CC
9 1/4" Long



667-305-NI
12" CC
12 9/16" Long



667-12-NI
12" CC appliance pull
12 13/16" Long



667-18-NI
18" CC appliance pull
18 13/16" Long



667S-NI
Small Knob
1 1/16" Dia.



667-NI
Knob
1 1/4" Dia.

| Item | MSRP |
|----------------|----------|
| 667S | \$5.40 |
| 667 | \$6.56 |
| 667L | \$8.10 |
| 667-3 | \$8.42 |
| 667-96 | \$11.46 |
| 667-128 | \$14.28 |
| 667-160 | \$17.22 |
| 667-224 | \$20.00 |
| 667-305 | \$54.72 |
| 667-12 | \$119.26 |
| 667-18 | \$149.70 |



667L-NI
Large Knob
1 3/8" Dia.

Regan

AVAILABLE FINISHES



DBAC SN PC BNBDL



847-96-BNBDL
3 3/4" CC
5 9/16" Long



847-128-BNBDL
5" CC
6 13/16" Long



847-160-BNBDL
6 1/4" CC
8 1/16" Long

| Item | MSRP |
|----------------|--------|
| 847-96 | \$4.36 |
| 847-128 | \$5.16 |
| 847-160 | \$5.82 |

330.897.7701

JEFFREY ALEXANDER

Renzo – NEW!

AVAILABLE FINISHES



MB BNBDL DBAC SBZ BG SN PC



141-96-BG
3 3/4" CC
4 5/8" Long



141-128-BG
5 1/16" CC
5 7/8" Long



141-160-BG
6 5/16" CC
7 1/8" Long



141-192-BG
7 9/16" CC
8 3/8" Long



141-305-BG
12" CC
12 7/8" Long



141-BG
Square Knob
1 1/4" Dia.



141L-BG
Square Knob
1 3/4" Dia.

| Item | MSRP |
|----------------|---------|
| 141 | \$5.50 |
| 141L | \$7.46 |
| 141-96 | \$11.20 |
| 141-128 | \$12.54 |
| 141-160 | \$15.78 |
| 141-192 | \$17.80 |
| 141-305 | \$44.92 |

Rhodes

AVAILABLE FINISHES



BNB BNBDL DACM DBAC SN



Z260-3-DACM
3" CC
3 3/4" Long



Z261-96-DACM
3 3/4" CC
4 1/2" Long



B812-96R-DACM
3 3/4" CC
6" Long



Z261-128-DACM
5" CC
5 13/16" Long



Z260-12-DACM
12" CC appliance pull
13 1/4" Long



S6060-DACM
Knob & backplate
1 1/4" Dia.

| Item | MSRP |
|-----------------|----------|
| S6060 | \$4.92 |
| Z260-3 | \$4.28 |
| Z261-96 | \$4.64 |
| B812-96R | \$7.16 |
| Z261-128 | \$12.70 |
| Z260-12 | \$119.26 |

Roman

AVAILABLE FINISHES

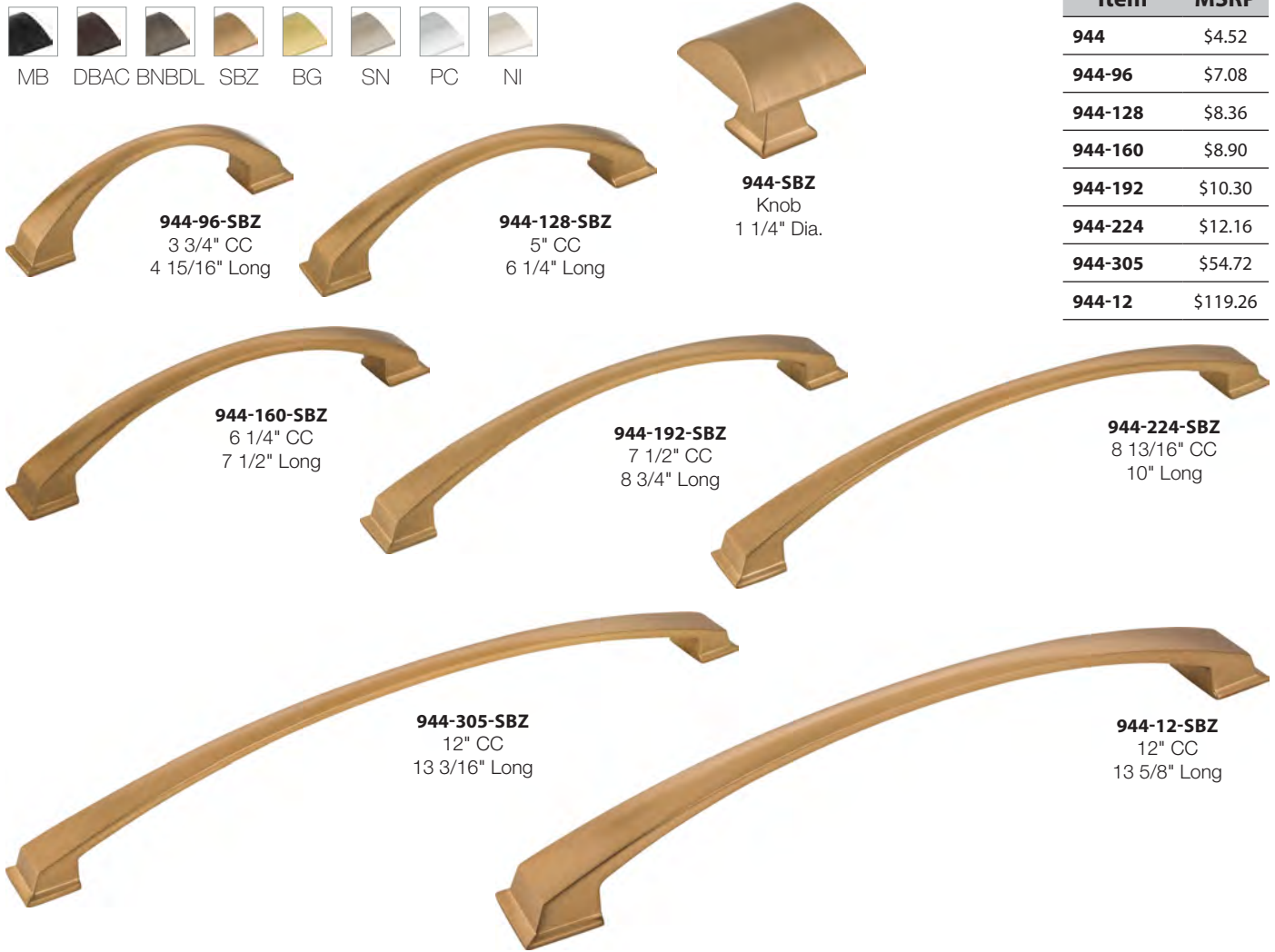

944-96-SBZ
3 3/4" CC
4 15/16" Long

944-128-SBZ
5" CC
6 1/4" Long

944-SBZ
Knob
1 1/4" Dia.

944-160-SBZ
6 1/4" CC
7 1/2" Long

944-192-SBZ
7 1/2" CC
8 3/4" Long

944-224-SBZ
8 13/16" CC
10" Long

944-305-SBZ
12" CC
13 3/16" Long

944-12-SBZ
12" CC
13 5/8" Long

| Item | MSRP |
|----------------|----------|
| 944 | \$4.52 |
| 944-96 | \$7.08 |
| 944-128 | \$8.36 |
| 944-160 | \$8.90 |
| 944-192 | \$10.30 |
| 944-224 | \$12.16 |
| 944-305 | \$54.72 |
| 944-12 | \$119.26 |

Royce

AVAILABLE FINISHES

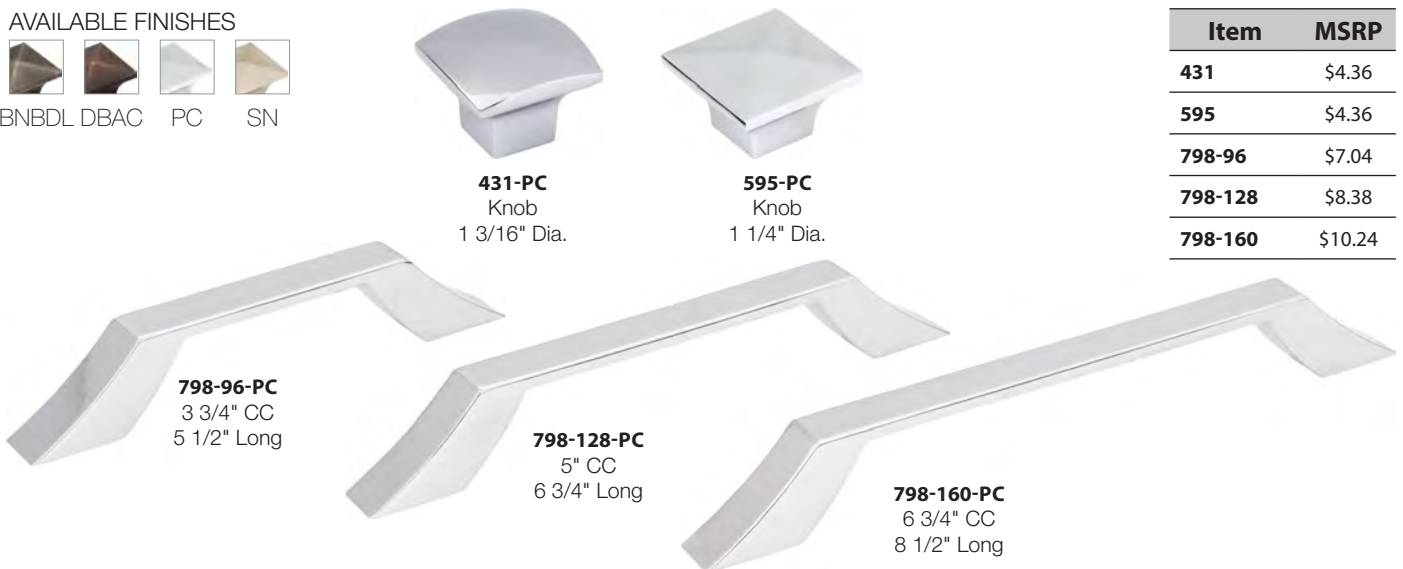

431-PC
Knob
1 3/16" Dia.

595-PC
Knob
1 1/4" Dia.

798-96-PC
3 3/4" CC
5 1/2" Long

798-128-PC
5" CC
6 3/4" Long

798-160-PC
6 3/4" CC
8 1/2" Long

| Item | MSRP |
|----------------|---------|
| 431 | \$4.36 |
| 595 | \$4.36 |
| 798-96 | \$7.04 |
| 798-128 | \$8.38 |
| 798-160 | \$10.24 |

Solana

AVAILABLE FINISHES

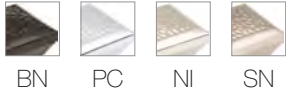

BN PC NI SN

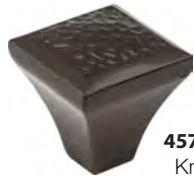

457-BN
Knob
1 1/4" Dia.

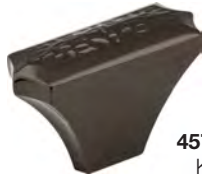

457L-BN
Knob
2" Dia.



457-96-BN
3 3/4" CC
6" Long

| Item | MSRP |
|---------------|---------|
| 457 | \$12.90 |
| 457L | \$13.32 |
| 457-96 | \$17.80 |

Sonoma

AVAILABLE FINISHES



BNBDL DBAC MB PC SN



431-MB
Knob
1 3/16" Dia.



4128-MB
5" CC
6 5/16" Long



4160-MB
6 1/4" CC
8" Long



4192-MB
7 9/16" CC
9 5/8" Long

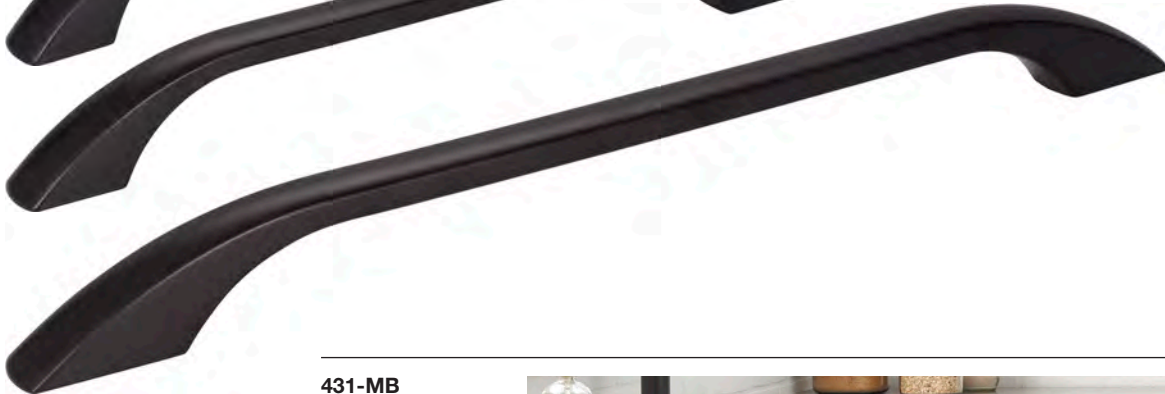

4288-MB
11 3/8" CC
14 7/16" Long

| Item | MSRP |
|-------------|---------|
| 431 | \$4.36 |
| 4128 | \$8.58 |
| 4160 | \$10.46 |
| 4192 | \$15.40 |
| 4288 | \$83.72 |

431-MB
Sonoma

4128-MB
Sonoma



Sullivan

AVAILABLE FINISHES



SN BNBDL DBAC MB PC



752-96-DBAC
96MM CC
4 1/2" Long

752-128-DBAC
128MM CC
5 13/16" Long

752-160-DBAC
160MM CC
7 1/16" Long

752-192-DBAC
192MM CC
8 15/16" Long

752-224-DBAC
224MM CC
9 9/16" Long



752-19-DBAC
19MM CC
1 1/4" Dia.

| Item | 1+ |
|----------------|---------|
| 752-19 | \$5.18 |
| 752-96 | \$5.92 |
| 752-128 | \$7.94 |
| 752-160 | \$9.88 |
| 752-192 | \$11.88 |
| 752-224 | \$13.86 |

Sutton

AVAILABLE FINISHES



BG BNBDL DBAC MB NI PC SBZ SN

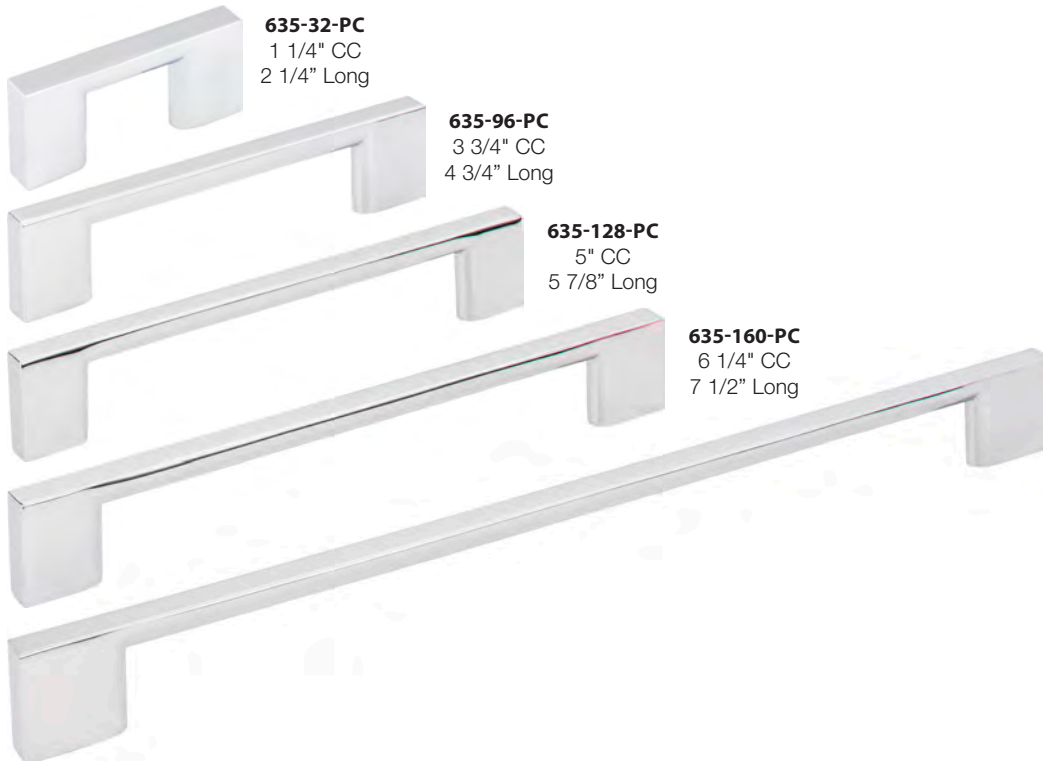

635-32-PC
1 1/4" CC
2 1/4" Long

635-96-PC
3 3/4" CC
4 3/4" Long

635-128-PC
5" CC
5 7/8" Long

635-160-PC
6 1/4" CC
7 1/2" Long

635-256-PC
10 1/16" CC
11 7/16" Long

| Item | MSRP |
|----------------|---------|
| 635-32 | \$6.88 |
| 635-96 | \$8.38 |
| 635-128 | \$10.02 |
| 635-160 | \$12.10 |
| 635-256 | \$28.26 |

Symphony

AVAILABLE FINISHES



SN BNBDL DACM DBAC ABSB



1976-ABSB
Knob
2" Dia.



1977S-ABSB
Knob
1 3/8" Dia.



1977-ABSB
3 3/4" CC
4 9/16" Long

| Item | MSRP |
|--------------|--------|
| 1977S | \$7.26 |
| 1976 | \$8.70 |
| 1977 | \$9.16 |

Tahoe

AVAILABLE FINISHES



BLK DMAC SIM

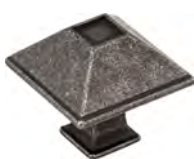

602S-SIM
Small knob
1 1/4" Dia.



602-SIM
Large knob
1 1/2" Dia.



602-96-SIM
3 3/4" CC
4 1/2" Long



602-128-SIM
5" CC
5 13/16" Long



602-12-SIM
12" CC
12 3/4" Long

| Item | MSRP |
|----------------|----------|
| 602S | \$11.36 |
| 602 | \$11.90 |
| 602-96 | \$14.62 |
| 602-128 | \$17.96 |
| 602-12 | \$128.32 |

602-12-DMAC
Tahoe

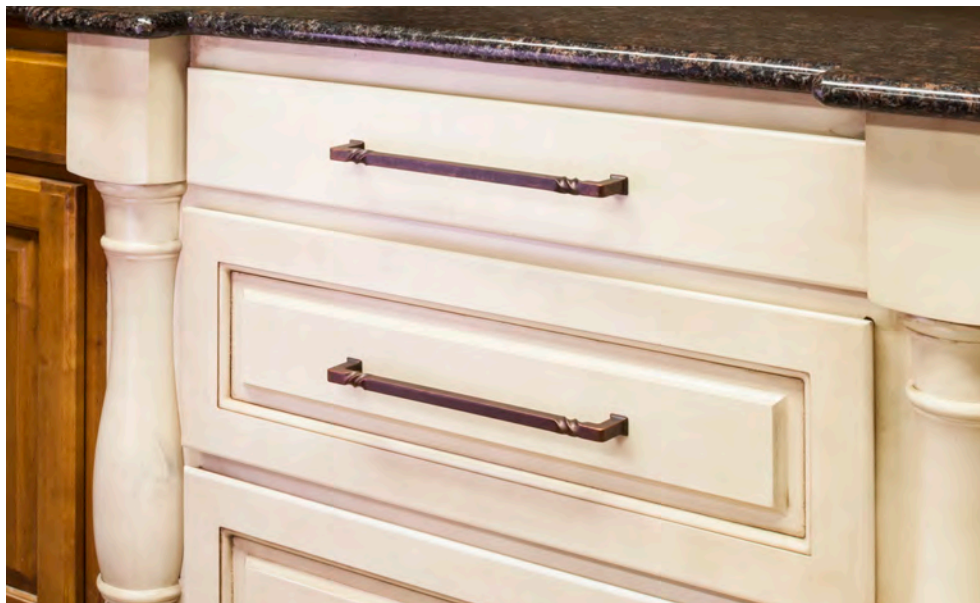

JEFFREY ALEXANDER®

by Hardware Resources

Tiffany

AVAILABLE FINISHES



BG BNBDL DBAC NI PC SBZ SN



658-SBZ

Knob
1 1/4" Dia.

| Item | MSRP |
|----------------|----------|
| 658 | \$8.80 |
| 658-96 | \$11.84 |
| 658-128 | \$14.82 |
| 658-160 | \$18.08 |
| 658-192 | \$20.84 |
| 658-224 | \$23.84 |
| 658-12 | \$119.26 |



658-96-SBZ
3 3/4" CC
4 1/2" Long



658-128-SBZ
5" CC
5 9/16" Long



658-160-SBZ
6 1/4" CC
7 1/16" Long



658-192-SBZ
7 9/16" CC
8 3/8" Long



658-224-SBZ
8 9/16" CC
9 7/8" Long

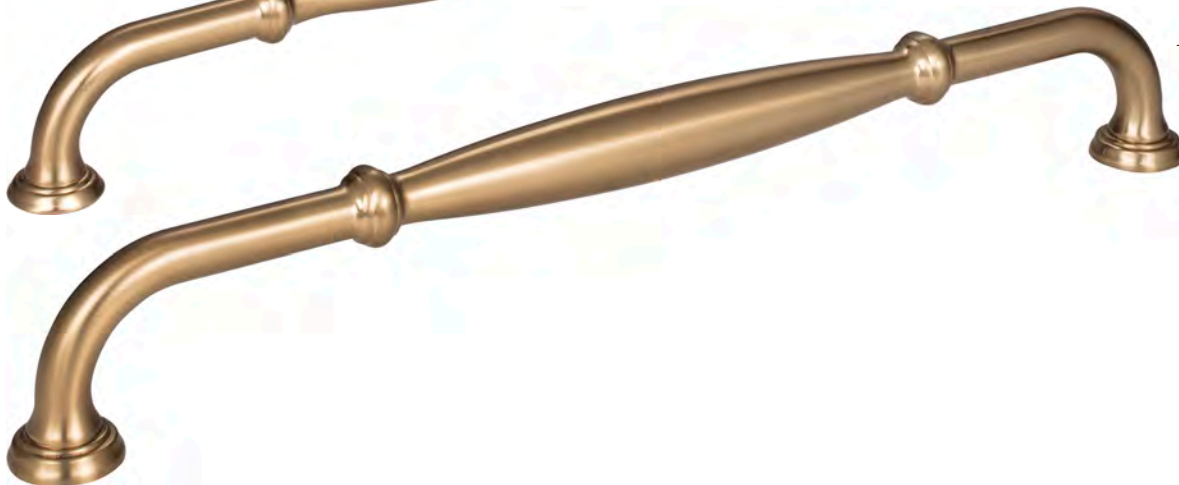

658-12-SBZ
12" CC appliance pull
13" Long

JEFFREY ALEXANDER

Tuscany

AVAILABLE FINISHES



ABSB DACM DBAC SIM



749-96B-SIM
3 3/4" CC
4 1/16" Long



749-SIM
Knob
2 5/16" Dia.

749-128B-SIM
5" CC
5 15/16" Long

749-128-SIM
5" CC bail pull
5 15/16" Long

749-160-SIM
6 1/4" CC bail pull
7 3/16" Long

749-224-SIM
8 13/16" CC bail pull
9 3/4" Long

| Item | MSRP |
|-----------------|---------|
| 749 | \$5.72 |
| 749-96B | \$5.64 |
| 749-128B | \$8.20 |
| 749-128 | \$9.96 |
| 749-160 | \$12.86 |
| 749-224 | \$14.34 |

JEFFREY ALEXANDER

585-96-DP
Delmar

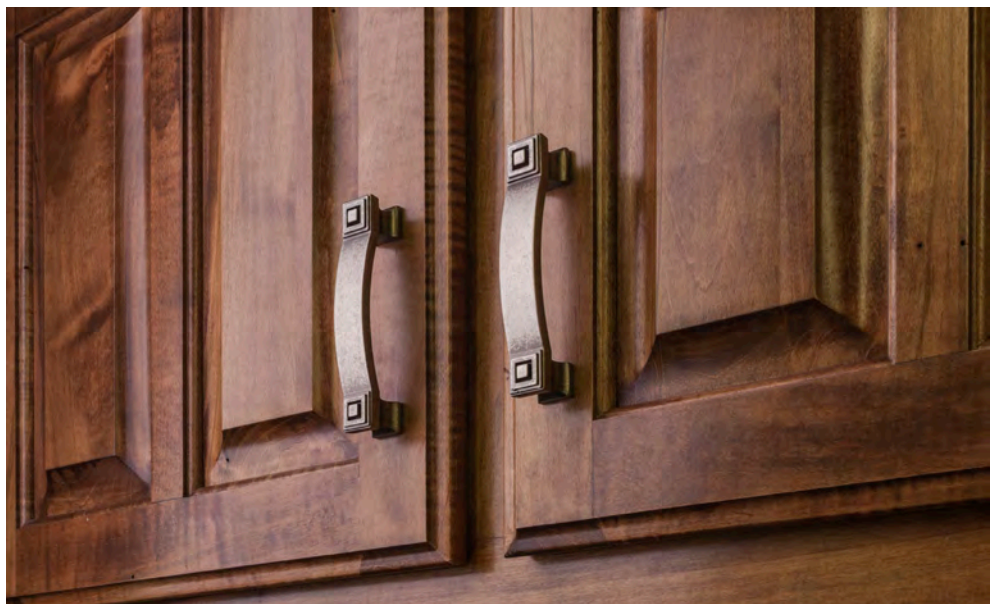

Zane

AVAILABLE FINISHES

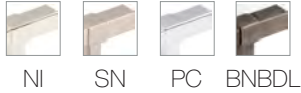

293T-BNBDL
Knob
2" Dia.



293-96-BNBDL
3 3/4" CC
5 1/16" Long



293-128-BNBDL
5" CC
6 7/16" Long



293-160-BNBDL
6 1/4" CC
7 9/16" Long



293-192-BNBDL
7 9/16" CC
8 13/16" Long



293-224-BNBDL
8 13/16" CC
10 1/16" Long



293-305-BNBDL
12" CC
13 3/4" Long

| Item | MSRP |
|----------------|---------|
| 293T | \$6.78 |
| 293-96 | \$10.36 |
| 293-128 | \$12.06 |
| 293-160 | \$13.96 |
| 293-192 | \$16.16 |
| 293-224 | \$18.44 |
| 293-305 | \$54.72 |

Zurich

AVAILABLE FINISHES



I350-ABSB
Knob
2" Dia.



I300-ABSB
3" CC
3 3/16" Long

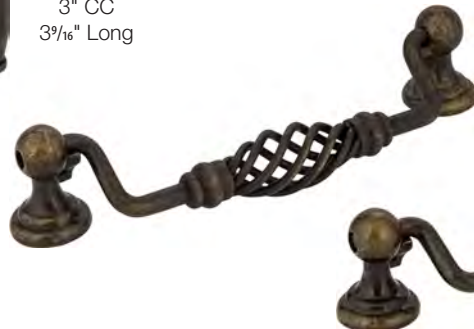

I350-128-ABSB
5" CC bail pull
5 5/16" Long

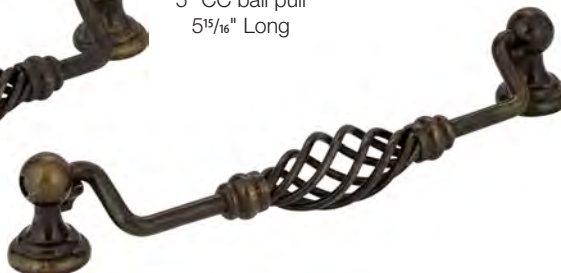

I350-160-ABSB
6 1/4" CC
7 3/16" Long

| Item | MSRP |
|-----------------|---------|
| I350 | \$4.26 |
| I300 | \$7.58 |
| I350-128 | \$10.68 |
| I350-160 | \$12.20 |



177-128-MB
Boswell



944-128-SBZ
Roman

JEFFREY ALEXANDER®
by Hardware Resources



5192-BG
Key Grande

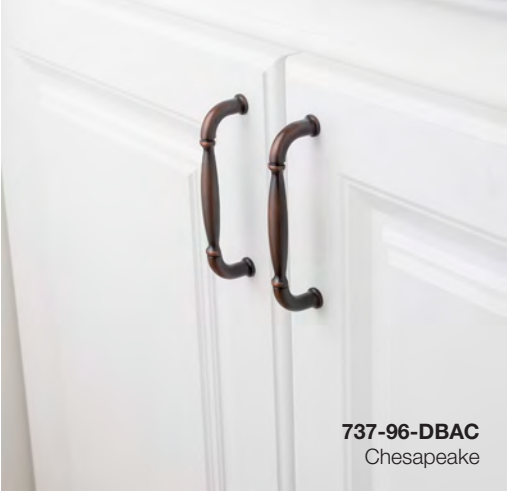

737-96-DBAC
Chesapeake



885-128-PC
Hayworth



264-128-PC
Alvar



141-SBZ | 141-305-SBZ
Renzo

E L E M E N T S[®]
by Hardware Resources

Aiden

AVAILABLE FINISHES



PC DBAC BNBDL SN



993-BNBDL
Knob
1 5/8" Proj.

| Item | MSRP |
|----------------|--------|
| 993 | \$2.66 |
| 993-3 | \$4.28 |
| 993-96 | \$5.16 |
| 993-128 | \$6.66 |



993-3-BNBDL
3" CC
4 1/16" Long



993-96-BNBDL
3 3/4" CC
4 13/16" Long



993-128-BNBDL
5 1/16" CC
6 1/8" Long

Arcadia

AVAILABLE FINISHES

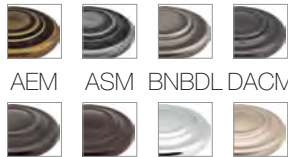

AEM ASM BNBDL DACM
DBAC ORB PC SN



516-AEM
3" CC
5 1/2" Long



107-AEM
Knob
1 1/4" Dia.

| Item | MSRP |
|------------|--------|
| 107 | \$4.10 |
| 516 | \$4.10 |

Asher

AVAILABLE FINISHES



SN BNBDL DBAC PC BC



193-3-BC
3" CC
3 1/4" Long



193-96-BC
3 3/4" CC
4" Long



193-4-BC
4" CC
4 1/4" Long



193-128-BC
5" CC
5 1/4" Long



193-160-BC
6 1/4" CC
6 9/16" Long

| Item | MSRP |
|----------------|--------|
| 193-3 | \$5.12 |
| 193-96 | \$5.64 |
| 193-4 | \$6.14 |
| 193-128 | \$6.92 |
| 193-160 | \$8.04 |

Belfast

AVAILABLE FINISHES



| Item | MSRP |
|------------|--------|
| 308-128-DN | \$4.48 |
| 406-128 | \$6.88 |
| 745-128 | \$5.50 |
| 776-128 | \$6.52 |
| 976-128 | \$5.98 |

308-128-DN
5" CC
5 1/2" Long

406-128-DN
5" CC
6 1/2" Long

745-128-DN
5" CC
5 1/2" Long

776-128-DN
5" CC
5 1/2" Long

976-128-DN
5" CC
6" Long

Brenton

AVAILABLE FINISHES

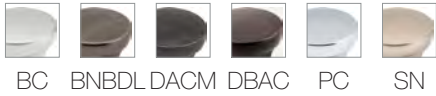

| Item | MSRP |
|---------|--------|
| 239 | \$1.70 |
| 239-96 | \$2.53 |
| 239-128 | \$3.25 |
| 239-160 | \$3.82 |
| 239-192 | \$4.19 |

239-BDBDL
Knob
1" Dia.

239-96-BNBDL
3 3/4" CC
4 5/16" Long

239-128-BNBDL
5" CC
5 9/16" Long

239-160-BNBDL
6 1/4" CC
6 13/16" Long

239-192-BNBDL
7 9/16" CC
8 1/16" Long

Calloway

AVAILABLE FINISHES

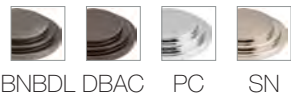

| Item | MSRP |
|---------|--------|
| 331 | \$2.82 |
| 351 | \$3.10 |
| 331L | \$3.58 |
| 351L | \$3.80 |
| 331-96 | \$5.32 |
| 351-96 | \$5.64 |
| 331-128 | \$5.82 |
| 351-128 | \$6.18 |

331-DBAC
Small Knob
1 1/8" Dia.

331L-DBAC
Large Knob
1 1/4" Dia.

351-DBAC
Small Knob
1 1/8" Dia.

351L-DBAC
Large Knob
1 1/4" Dia.

331-96-DBAC
3 3/4" CC
4 1/2" Long

351-96-DBAC
3 3/4" CC
4 7/16" Long

331-128-DBAC
5" CC
5 3/4" Long

351-128-DBAC
5" CC
5 11/16" Long

Capri

AVAILABLE FINISHES



412461-SN
Knob
1 1/8" Dia.



530142-SN
Knob
1" Dia.



530143-DN
Knob
1 1/4" Dia.



3211-SN
3" CC
4 7/8" Long



4656-SN
3" CC
3 3/8" Long



411689-DN
3 3/4" CC
4 3/8" Long



4690-SN
3 3/4" CC
4 1/2" Long



530144-DN
3 3/4" CC
5 1/8" Long



417572-DN
5" CC
4 1/2" Long



Z205-BB
5" CC
5 3/4" Long



Z500-128-SN
5" CC
5 5/8" Long

| Item | MSRP |
|-----------------|--------|
| 412461 | \$2.66 |
| 530142 | \$2.62 |
| 530143 | \$2.66 |
| 3211 | \$3.14 |
| 4656 | \$4.28 |
| 411689 | \$3.00 |
| 4690 | \$3.10 |
| 530144 | \$2.66 |
| 417572 | \$3.96 |
| Z205 | \$4.64 |
| Z500-128 | \$9.28 |

NOTE: 412461, 530142, 3211, 4656, 4690 and Z500-128 are only available in SN Finish. 531043, 411689, 530144 and 417572 are only available in DN Finish. Z205 is only available in BB or BC Finishes.

Cosgrove

AVAILABLE FINISHES

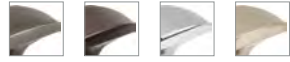

BNBDL DBAC PC SN

| Item | MSRP |
|----------------|--------|
| 382 | \$2.92 |
| 382-96 | \$6.84 |
| 382-128 | \$7.94 |
| 382-160 | \$9.16 |

382-BNBDL
Knob
1 1/2" Dia.

382-96-BNBDL
3 3/4" CC
6 1/2" Long

382-128-BNBDL
5" CC
7 3/4" Long

382-160-BNBDL
6 1/4" CC
9" Long

Cypress

AVAILABLE FINISHES



BNBDL DACM DBAC SN

| Item | MSRP |
|----------------|--------|
| Z118 | \$2.04 |
| Z118-3 | \$2.56 |
| Z118-96 | \$2.92 |

Z118-DACM
Knob
1 1/4" Dia.

Z118-3-DACM
3" CC
3 3/8" Long

Z118-96-DACM
3 3/4" CC
4 1/8" Long

Drake

AVAILABLE FINISHES



BNBDL DACM DBAC PC SN

| Item | MSRP |
|---------------|--------|
| 423 | \$3.88 |
| 424 | \$4.16 |
| 423-3 | \$4.20 |
| 423-96 | \$4.92 |

423-DBAC
Faceted Knob
1 1/4" Dia.

424-DBAC
Flat Top Knob
1 3/16" Dia.

423-3-DBAC
3" CC
4" Long

423-96-DBAC
3 3/4" CC
4 3/4" Long

Edgefield

AVAILABLE FINISHES

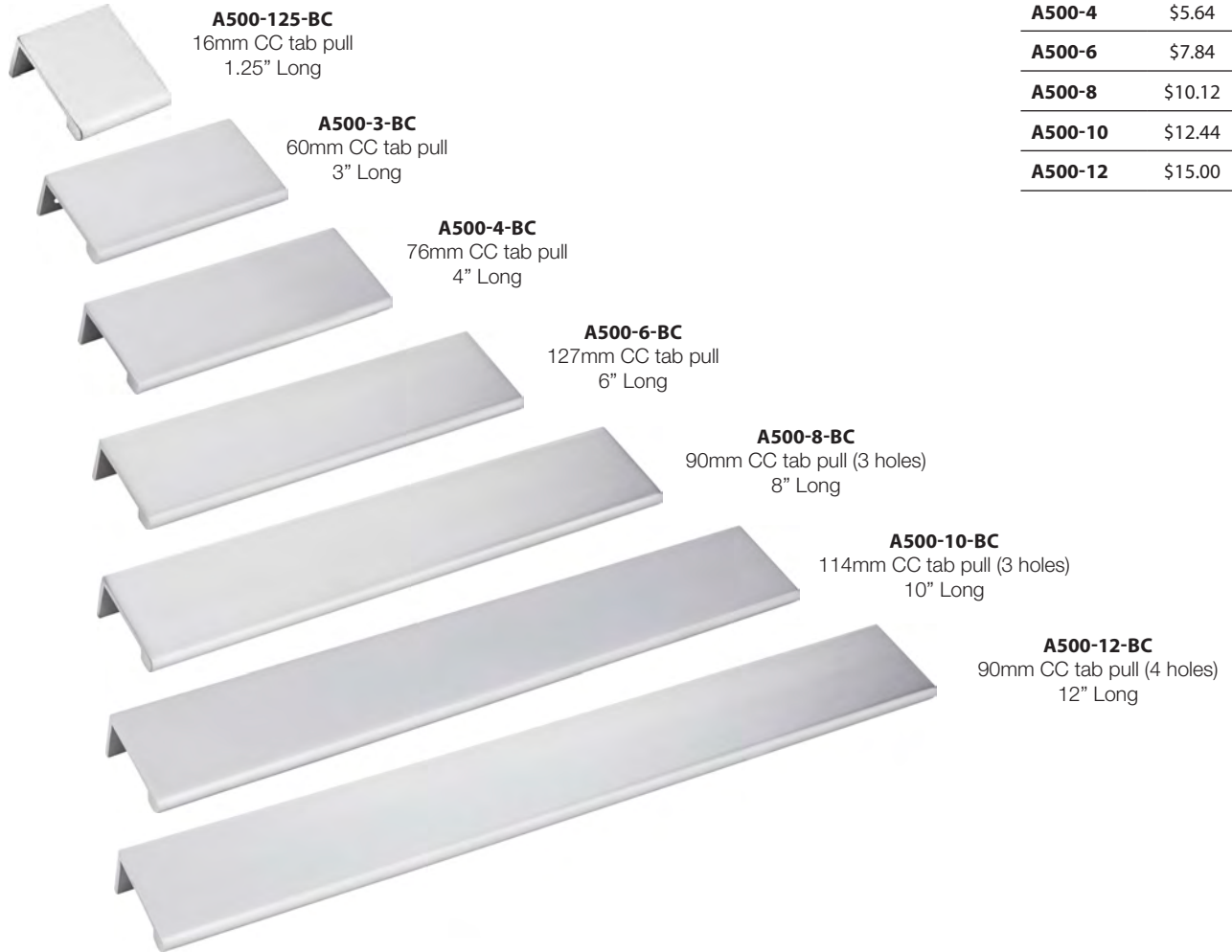
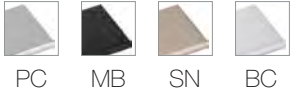

| Item | MSRP |
|-----------------|---------|
| A500-125 | \$3.30 |
| A500-3 | \$4.54 |
| A500-4 | \$5.64 |
| A500-6 | \$7.84 |
| A500-8 | \$10.12 |
| A500-10 | \$12.44 |
| A500-12 | \$15.00 |

Florence

AVAILABLE FINISHES

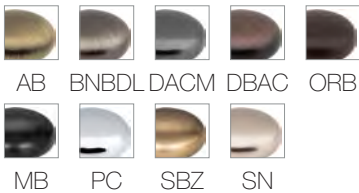

2980-SBZ
Knob
1 1/4" Dia.



2981-SBZ
3" CC cup pull
3 11/16" Long

| Item | MSRP |
|-------------|--------|
| 2980 | \$4.22 |
| 2981 | \$5.54 |

Gatsby

AVAILABLE FINISHES



BNBDL DACM DBAC PC SN

| Item | MSRP |
|------|--------|
| 3940 | \$1.82 |
| 3950 | \$1.72 |
| 3960 | \$2.46 |
| 3970 | \$2.14 |
| 3108 | \$2.60 |
| 3208 | \$2.92 |
| 3308 | \$2.82 |



3940-PC
Knob
1 1/4" Dia.



3950-PC
Knob
1 3/16" Dia.



3960-PC
Knob
1 1/4" Dia.



3970-PC
Knob
1 1/8" Dia.



3108-PC
3" CC
5 1/4" Long



3208-PC
3" CC
4 1/4" Long



3308-PC
3" CC
4 1/2" Long

Glendale

AVAILABLE FINISHES



ABM-DBNBDL DBAC DMAC

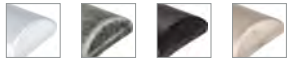

PC SIM MB SN



SBZ



525-SIM
Knob
1" Dia.



525-96-SIM
3 3/4" CC
5" Long

| Item | MSRP |
|--------|--------|
| 525 | \$3.78 |
| 525-96 | \$4.84 |



993-128-DBAC
Aiden

Hadly

AVAILABLE FINISHES

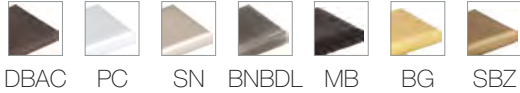

DBAC

PC

SN

BNBDL

MB

BG

SBZ



449-BNBDL
Knob
1" Dia.

| Item | MSRP |
|----------------|---------|
| 449 | \$3.58 |
| 449-3 | \$5.98 |
| 449-96 | \$6.34 |
| 449-128 | \$8.38 |
| 449-160 | \$11.24 |



449-3-BNBDL
3" CC
4" Long



449-96-BNBDL
96 mm CC
4 3/4" Long



449-128-BNBDL
5" CC
6 1/16" Long



449-160-BNBDL
6 1/4" CC
7 5/16" Long

Hammond

AVAILABLE FINISHES



BNBDL DBAC

PC

SN



525-SN
Knob
1" Dia.

| Item | MSRP |
|---------------|--------|
| 525 | \$3.78 |
| 937-3 | \$3.00 |
| 937-96 | \$4.36 |



937-3-SN
3" CC
4 7/8" Long



937-96-SN
3 3/4" CC
5 11/16" Long

Kenner

AVAILABLE FINISHES



PC BNBDL DBAC SN



254-3-BNBDL
3" CC
5" Long

254-96-SN
3 3/4" CC
5 3/4" Long

3970-SN
Knob
1 1/8" Dia.

| Item | MSRP |
|---------------|--------|
| 3970 | \$2.14 |
| 254-3 | \$3.00 |
| 254-96 | \$4.36 |

Knox

AVAILABLE FINISHES



MB SN PC

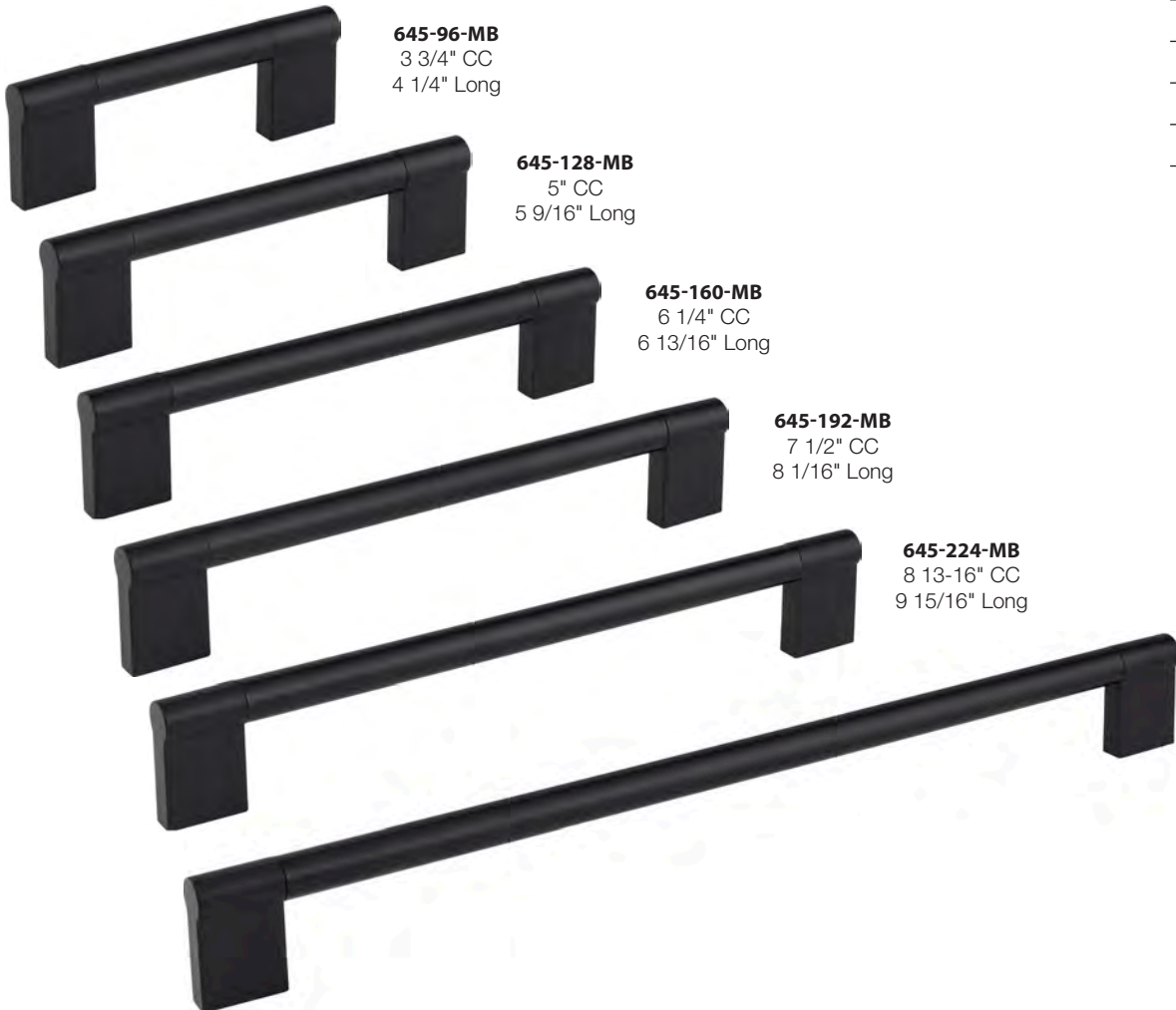

645-96-MB
3 3/4" CC
4 1/4" Long

645-128-MB
5" CC
5 9/16" Long

645-160-MB
6 1/4" CC
6 13/16" Long

645-192-MB
7 1/2" CC
8 1/16" Long

645-224-MB
8 13-16" CC
9 15/16" Long

645-320-MB
12 1/2" CC
13 1/16" Long

| Item | MSRP |
|----------------|---------|
| 645-96 | \$6.88 |
| 645-128 | \$8.00 |
| 645-160 | \$9.16 |
| 645-192 | \$10.52 |
| 645-224 | \$12.10 |
| 645-320 | \$13.80 |

Lindos

AVAILABLE FINISHES



BNBDL DBAC PC SN



Z115-BNBDL
Knob
1 1/4" Dia.



Z115L-BNBDL
Knob
1 3/8" Dia.



Z115-96-BNBDL
3 3/4" CC
4 3/8" Long



Z115-128-BNBDL
5" CC
5 9/16" Long

| Item | MSRP |
|-----------------|---------|
| Z115 | \$3.40 |
| Z115L | \$3.10 |
| Z115-96 | \$3.94 |
| Z115-128 | \$10.52 |

Madison

AVAILABLE FINISHES

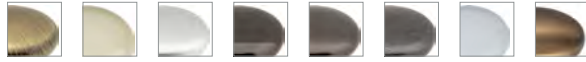

AB ALM BC BN BNBDL DACM WH SBZ



DBAC MB ORB PB SB SN PC



3910-AB
Knob
1 3/16" Dia.



Z259-3-AB
3" CC
3 3/8" Long



Z259-12-AB
12" CC appliance pull
13" Long

| Item | MSRP |
|----------------|----------|
| 3910 | \$2.76 |
| Z259-3 | \$3.14 |
| Z259-12 | \$115.64 |

NOTE: Z259-3 is not available in ALM or WH Finishes. Z259-12 is not available in ALM, BNBDL, MB, PB, SB or WH Finishes.

Naples

AVAILABLE FINISHES



40-PC
Knob
40mm Dia.

136-SN
3" CC
156mm Long

156-MB
96mm CC
156mm Long

176-BG
128mm CC
176mm Long

206-SBZ
128mm CC
206mm Long

220-PC
160mm CC
220mm Long

272-SN
192mm CC
272mm Long

304-MB
224mm CC
304mm Long

336-BG
256mm CC
336mm Long

368-SBZ
288mm CC
368mm Long

399-PC
319mm CC
399mm Long

| Item | MSRP |
|------|---------|
| 40 | \$3.04 |
| 136 | \$4.16 |
| 156 | \$5.06 |
| 176 | \$6.02 |
| 206 | \$7.52 |
| 220 | \$6.66 |
| 272 | \$7.64 |
| 304 | \$8.28 |
| 336 | \$9.06 |
| 368 | \$9.72 |
| 399 | \$10.56 |
| 496 | \$12.70 |
| 560 | \$14.14 |
| 624 | \$15.72 |
| 720 | \$18.02 |
| 763 | \$19.04 |

| | |
|-----|------------------------|
| 496 | 416mm CC 496mm Long |
| 560 | 480mm CC 560mm Long |
| 624 | 544mm CC 624mm Long |
| 720 | 640mm CC 720mm Long |
| 763 | 673mm CC 763mm Long |

Naples

AVAILABLE FINISHES



SS



39-SS
Knob
39mm Dia.



154-SS
96mm CC
154mm Long



174-SS
128mm CC
174mm Long



204-SS
128mm CC
204mm Long



270-SS
192mm CC
270mm Long



302-SS
224mm CC
302mm Long



334-SS
256mm CC
334mm Long



366-SS
288mm CC
366mm Long

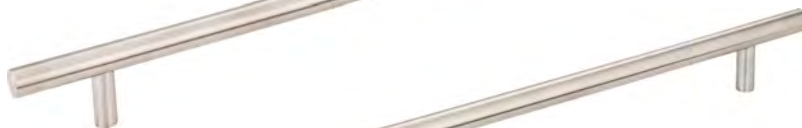

397-SS
319mm CC
397mm Long

| Item | MSRP |
|------------|---------|
| 39 | \$2.56 |
| 154 | \$3.88 |
| 174 | 2.51 |
| 204 | \$6.68 |
| 270 | \$7.16 |
| 302 | \$7.72 |
| 334 | \$7.96 |
| 366 | \$8.68 |
| 397 | \$9.56 |
| 494 | \$11.78 |
| 558 | \$13.08 |
| 622 | \$14.24 |
| 719 | \$16.10 |
| 761 | \$17.22 |

494-SS
416mm CC
494mm Long

558-SS
480mm CC
558mm Long

622-SS
544mm CC
622mm Long

719-SS
640mm CC
719mm Long

761-SS
673mm CC
761mm Long

206-MB
Naples



Merryville

AVAILABLE FINISHES

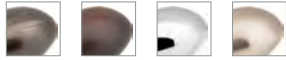

BNBDL DBAC PC SN



897-BNBDL
Knob
1 1/8" Dia.



897L-BNBDL
Knob
1 1/4" Dia.



897-3-BNBDL
3" CC
5 1/8" Long

| Item | MSRP |
|--------------|--------|
| 897 | \$2.76 |
| 897L | \$3.40 |
| 897-3 | \$3.10 |

Sedona

AVAILABLE FINISHES



SN



400-SN
3" CC
4" Long



26-SN
Knob
1" Dia.



475-SN
3 3/4" CC
4 3/4" Long



600-SN
5" CC
6" Long

| Item | MSRP |
|------------|--------|
| 26 | \$3.40 |
| 400 | \$5.48 |
| 475 | \$6.84 |
| 600 | \$9.44 |

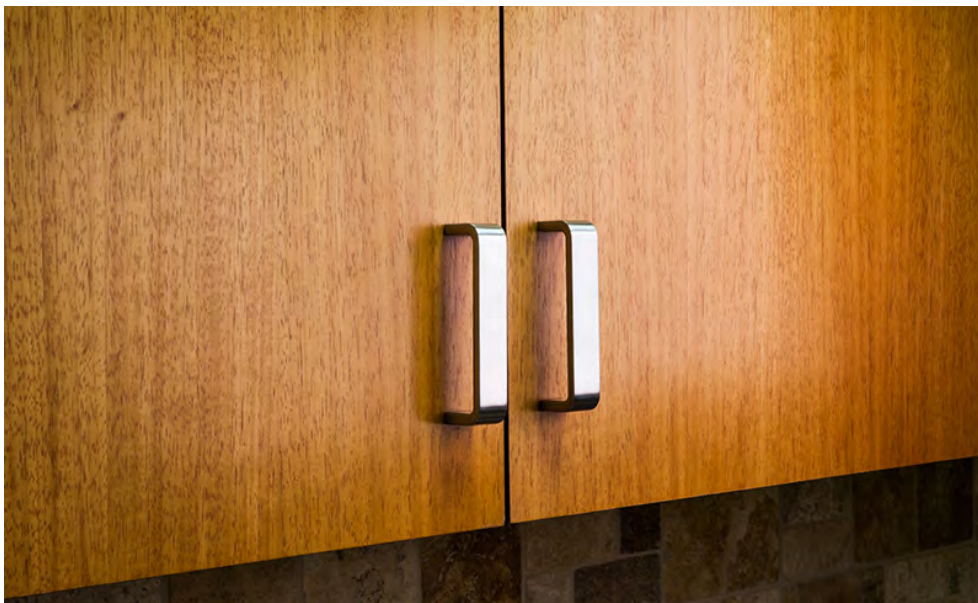

193-96-BC
Asher

Slade

AVAILABLE FINISHES



PC BNBDL SN DBAC AB DACM PB

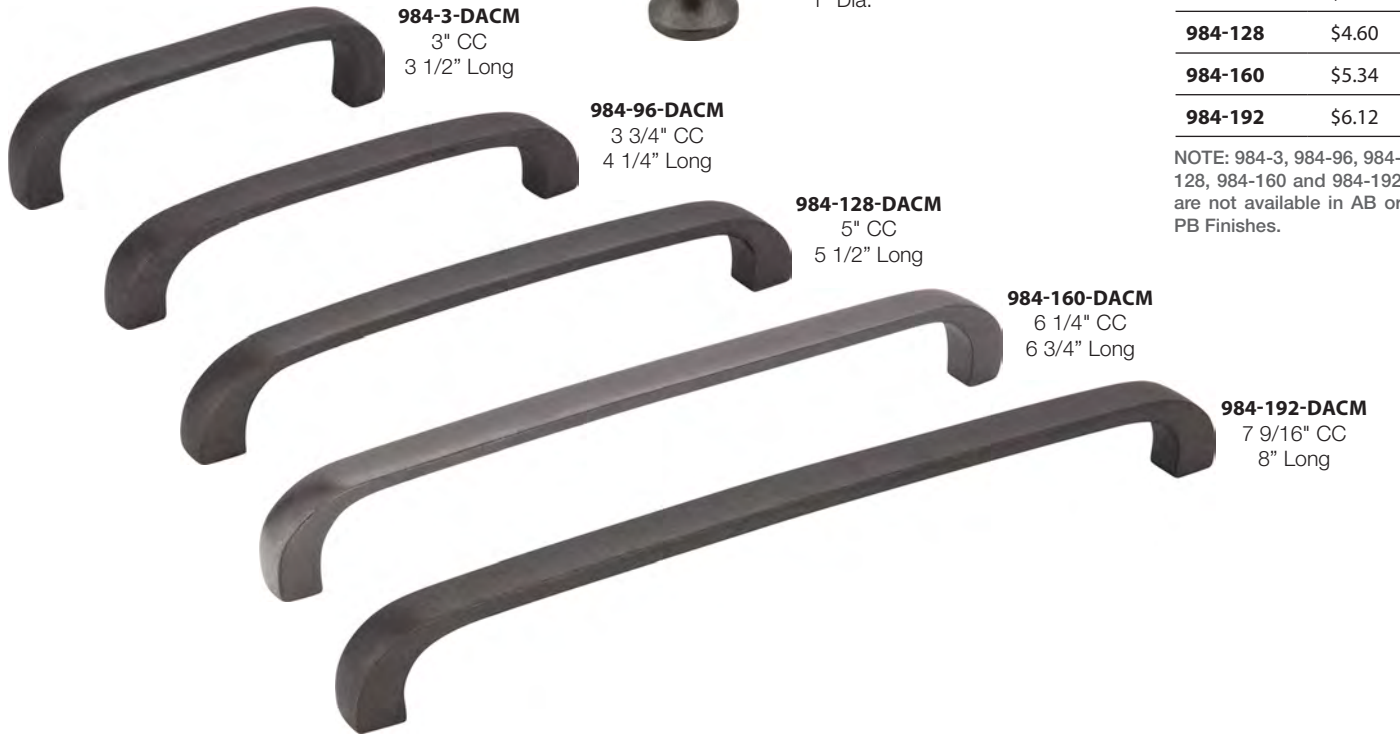

984-3-DACM
3" CC
3 1/2" Long

984-96-DACM
3 3/4" CC
4 1/4" Long

984-128-DACM
5" CC
5 1/2" Long

984-160-DACM
6 1/4" CC
6 3/4" Long

984-192-DACM
7 9/16" CC
8" Long



3915-DACM
Knob
1" Dia.

| Item | MSRP |
|----------------|--------|
| 3915 | \$1.96 |
| 984-3 | \$3.48 |
| 984-96 | \$4.00 |
| 984-128 | \$4.60 |
| 984-160 | \$5.34 |
| 984-192 | \$6.12 |

NOTE: 984-3, 984-96, 984-128, 984-160 and 984-192 are not available in AB or PB Finishes.

Somerset

AVAILABLE FINISHES



BNBDL DBAC PC SN



8004-DBAC
3 3/4" CC
4 7/8" Long

81065-DBAC
5" CC
6" Long

80814-DBAC
3 3/4" CC
5" Long

80815-DBAC
5" CC
6 1/4" Long

| Item | MSRP |
|--------------|--------|
| 8004 | \$3.62 |
| 81065 | \$4.36 |
| 80814 | \$2.92 |
| 80815 | \$4.36 |

Stanton

AVAILABLE FINISHES

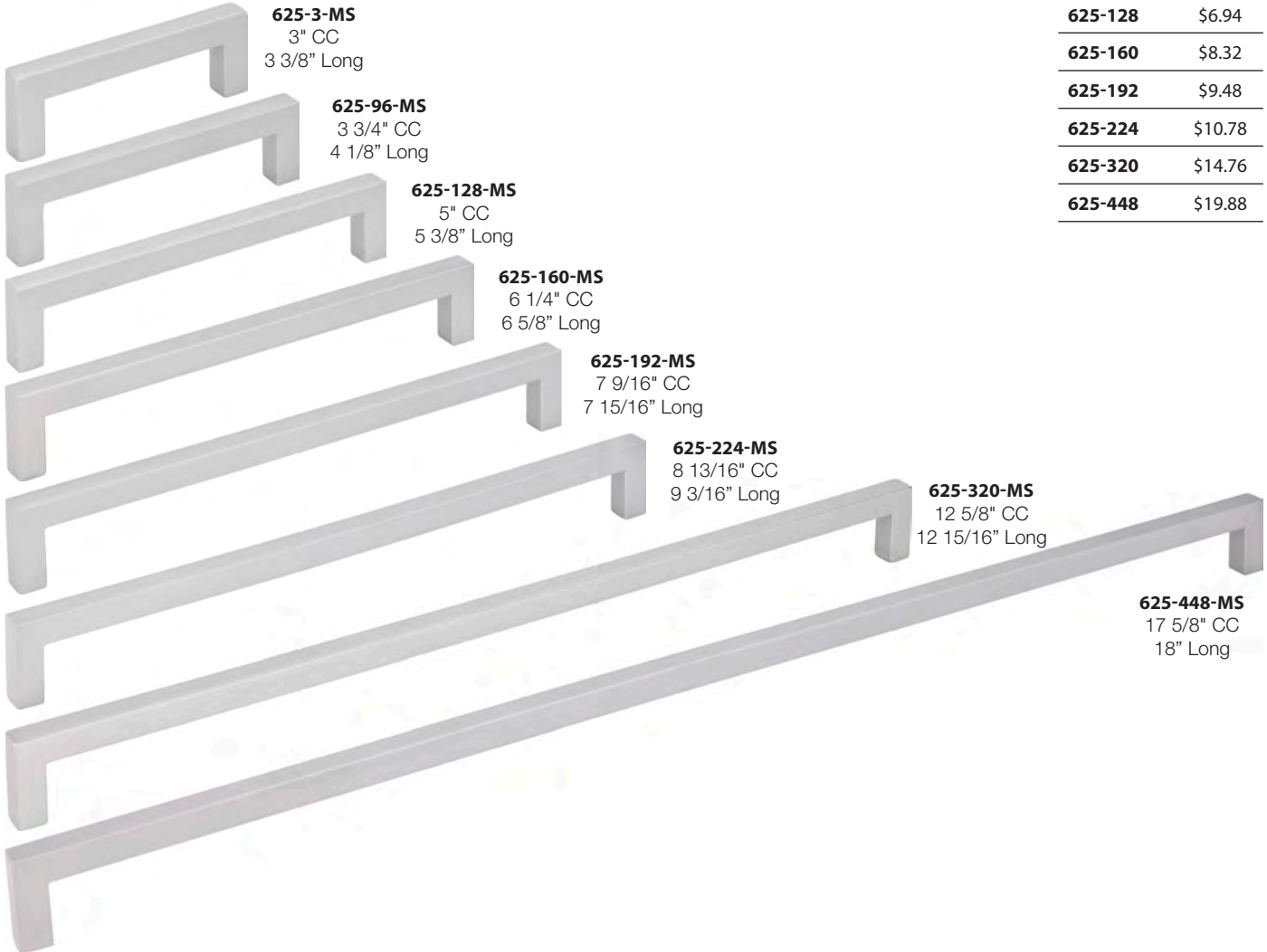

625-3-MS
3" CC
3 3/8" Long

625-96-MS
3 3/4" CC
4 1/8" Long

625-128-MS
5" CC
5 3/8" Long

625-160-MS
6 1/4" CC
6 5/8" Long

625-192-MS
7 9/16" CC
7 15/16" Long

625-224-MS
8 13/16" CC
9 3/16" Long

625-320-MS
12 5/8" CC
12 15/16" Long

625-448-MS
17 5/8" CC
18" Long

| Item | MSRP |
|----------------|---------|
| 625-3 | \$4.90 |
| 625-96 | \$5.96 |
| 625-128 | \$6.94 |
| 625-160 | \$8.32 |
| 625-192 | \$9.48 |
| 625-224 | \$10.78 |
| 625-320 | \$14.76 |
| 625-448 | \$19.88 |

Strickland

AVAILABLE FINISHES



771-3-SN
3" CC
4 1/2" Long

771-96-SN
3 3/4" CC
5 3/16" Long

771-128-SN
5" CC
6 5/16" Long

771-160-SN
6 1/4" CC
7 11/16" Long

| Item | MSRP |
|----------------|--------|
| 771-3 | \$5.38 |
| 771-96 | \$5.60 |
| 771-128 | \$6.50 |
| 771-160 | \$7.68 |

330.897.7701

Syracuse

AVAILABLE FINISHES



BNBDL DBAC PC SN



575-96-BNBDL
3 3/4" CC
4 7/8" Long



575-BNBDL
Knob
1 3/16" Dia.

| Item | MSRP |
|---------------|--------|
| 575 | \$1.41 |
| 575-96 | \$2.82 |

Thatcher

AVAILABLE FINISHES



MB DBAC BNBDL SBZ BG SN PC



859-3-SBZ
3" CC
5 1/4" Long



859T-SBZ
Knob
1 1/2" Dia.



859-96-SBZ
3 3/4" CC
6" Long



859-128-SBZ
5" CC
7 1/4" Long



859-160-SBZ
6 1/4" CC
8 1/2" Long

| Item | MSRP |
|----------------|--------|
| 859T | \$2.82 |
| 859-3 | \$3.78 |
| 859-96 | \$4.48 |
| 859-128 | \$5.38 |
| 859-160 | \$7.42 |













859-128-SBZ
Thatcher



Torino

AVAILABLE FINISHES



| | | | |
|---|---|---|---|
|  A271-3AL 3" CC 3 3/8" Long |  K271-3SS 3" CC 3 3/8" Long |  S271-3-PB 3" CC 3 3/8" Long | |
|  A271-3.5AL 3 1/2" CC 3 13/16" Long |  K271-3.5-SS 3 1/2" CC 3 13/16" Long |  S271-3.5-PB 3 1/2" CC 3 13/16" Long | |
|  A271-96AL 3 3/4" CC 4 1/8" Long |  K271-96-SS 3 3/4" CC 4 1/8" Long |  S271-96-PB 3 3/4" CC 4 1/8" Long |  S271-128-PB 5" CC 5 3/8" Long |
|  A271-4AL 4" CC 4 5/16" Long |  K271-4SS 4" CC 4 5/16" Long |  S271-4-PB 4" CC 4 5/16" Long | |

| Item | MSRP |
|-------------|--------|
| A271-3AL | \$1.60 |
| K271-3SS | \$4.38 |
| S271-3 | \$2.18 |
| A271-3.5AL | \$1.70 |
| K271-3.5-SS | \$3.96 |
| S271-3.5 | \$2.28 |
| A271-96AL | \$1.72 |
| K271-96-SS | \$4.10 |
| S271-96 | \$2.34 |
| A271-4AL | \$1.80 |
| K271-4SS | \$4.86 |
| S271-4 | \$2.44 |
| S271-128 | \$2.62 |

Vienna

AVAILABLE FINISHES

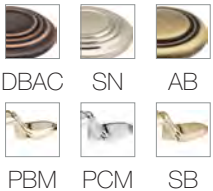

| | | |
|--|--|--|
|  110-DBAC Knob 1 1/4" Dia. |  202-DBAC Knob 1 1/4" Dia. | |
|  110-3-DBAC 3" CC 5 1/2" Long |  P106-DBAC 3" CC 5" Long | |

| Item | MSRP |
|-------|--------|
| 110 | \$2.56 |
| 202 | \$1.86 |
| 110-3 | \$3.80 |
| P106 | \$2.92 |

NOTE: AB Finish is only available for 202. PBM, PCM or SB Finishes are only available for P106.

Watervale

AVAILABLE FINISHES

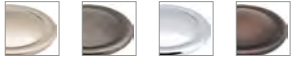

SN BNBDL PC DBAC

| Item | MSRP |
|--------|--------|
| 647 | \$2.44 |
| 647-3 | \$3.00 |
| 647-96 | \$4.36 |



647-DBAC
Knob
1 1/8" Dia.



647-3-DBAC
3" CC
4 5/8" Long



647-96-DBAC
3 3/4" CC
5 3/8" Long

Westbury

AVAILABLE FINISHES



BNBDL DBAC PC SN

| Item | MSRP |
|------|--------|
| 3898 | \$3.78 |
| 3899 | \$3.00 |



3898-PC
Knob
1 1/4" Dia.



3899-PC
3" CC
5 1/8" Long

Zachary

AVAILABLE FINISHES

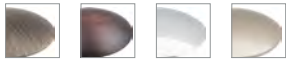

BNBDL DBAC PC SN

| Item | MSRP |
|---------|--------|
| 988 | \$2.52 |
| 988-3 | \$3.40 |
| 988-96 | \$4.68 |
| 988-128 | \$5.48 |
| 988-160 | \$7.30 |



988-3-SN
3" CC
3 3/4" Long



988-SN
Knob
1 1/6" Dia.



988-96-SN
3 3/4" CC
4 1/2" Long



988-128-SN
5" CC
5 3/4" Long



988-160-SN
6 1/4" CC
7 1/16" Long



**For Hershberger Hardware
Orders Please Contact:**

DIRECT LINES FOR QUESTIONS OR ORDERS

330-897-7701

FAX ORDERS 330-897-3366

CUSTOMER SERVICE 330-897-0002

Monday - Friday 6:30 AM - 3:30 PM

OHIO SALES

Josh Mast 330-763-3837

Did you know that we can do Custom Hardware?

We work directly with Factories in the U.S. and overseas.

We can make Metal Legs, Pulls, Knobs, Ferrules, Turnbuckles, etc. to your specifications!

Call us with your next commercial project.



Catalog proudly designed and printed by:



SCHLABACH PRINTERS

schlabachprinters.com



Front Cover: Appoint - page 13 | Back Cover: Stature - page 44

The **H**ERSHBERGER'S
hardware *ltd.*

330-897-7701

customer service

330-897-0002

fax orders

330-897-3366

email

orders.hershbergerhardware@emyprinter.net

1411 Township Road 178, Baltic, Ohio 43804

Amerock